

# Understanding Multichannel Television Sound (MTS)

All TV-video systems receive and/or process the audio portion of the TV signal. The audio circuits may receive only the monaural portion or may decode the MTS stereo and SAP audio signals as well. The Electronics Industry Association (EIA) reports that sales of MTS Stereo TV receivers have enjoyed six straight years of double digit increases. MTS Stereo decoder circuits are now virtually standard in projection and large direct view TV receivers and are included in a growing number of VCRs.

The strong acceptance and growth of MTS Stereo along with a growing consumer demand for higher TV audio performance means audio will become more a part of daily service check outs and troubleshooting routines. This Tech Tip covers the theory of Multichannel Television Sound (MTS) or simply Stereo TV.

## The Standard TV System

One requirement of a stereo TV system was that an existing TV receiver produce normal sound output while receiving a TV stereo broadcast signal. Thus, the method created for stereo TV had to begin with the standard TV signal.

The standard TV signal consists of a video carrier, which is amplitude modulated with both composite video and a double sideband suppressed carrier (DSBSC) color signal at 3.58 Mhz. The resulting video modulation sidebands extend 4.2 Mhz above the video carrier, but only 1.25 Mhz below (See Figure 2).

The color signal is formed in a balanced modulator by amplitude modulating a 3.58 Mhz subcarrier with color information. The 3.58 Mhz subcarrier is phase-locked to the

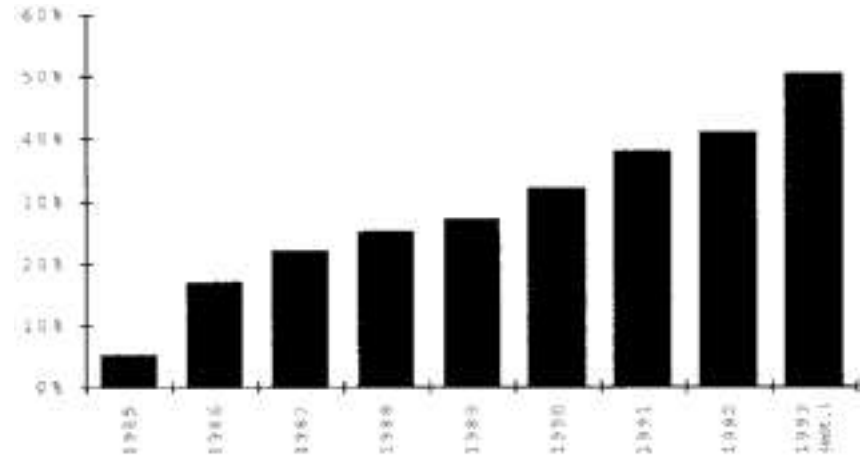

Fig. 1: Since their introduction, MTS/SAP decoder circuits have grown in popularity to the point where they are included in over 50% of the color TV receiver/monitors sold each year.

horizontal scan to reduce interference between the two signals. The balanced modulator produces amplitude modulated color sidebands, but blocks (suppresses) the subcarrier.

A sample (burst) of the original 3.58 Mhz subcarrier is transmitted with the video. This is done to allow the receiver to reinsert a 3.58 Mhz subcarrier into the color sideband signals before demodulation. The receiver uses the burst to phase-lock the recreated subcarrier.

The station also transmits an audio carrier, which is 4.5 Mhz above the video carrier. The audio carrier is frequency modulated with signals ranging from 50 Hz to 15 kHz. The high frequency audio signals are modulated at higher levels (boosted) than the low frequency signals to help overcome the high frequency noise present in an FM transmission. This is called preemphasis. The filter used to boost the high frequency signals has an RC time constant of 75 microsecond, thus the process is called 75 microsecond

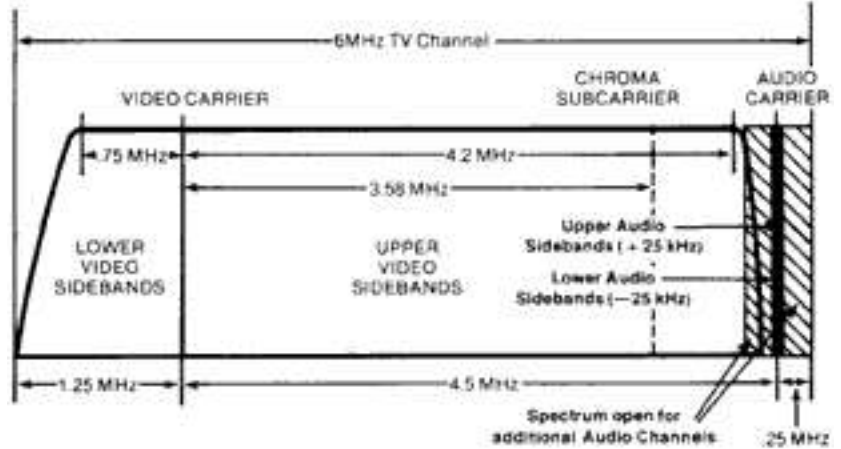

Fig. 2: Standard N channel. Note positioning of MTS Stereo audio signals.

preemphasis. The audio carrier is also phase-locked to the video carrier to reduce interference between the audio and video signals.

The audio sidebands extend 25 kHz above and below the audio carrier (See Figure 1). The MTS Stereo system utilizes the remaining space above and below the carrier to add the stereo audio signal.

### A TV Stereo Sound Standard

On April 23, 1984, after considering several manufacturer's systems, the FCC adopted a proposal by the Broadcast Television Systems Committee (BTSC) of the Electronics Industries Association (EIA). The BTSC system provides for multiple audio channels to be transmitted within the U.S. standard television signal.

The system chosen was developed by Zenith and called multichannel television sound (MTS). The MTS system maintains compatibility with existing non-stereo TV receivers while providing high quality stereo sound and second audio program (SAP). MTS incorporates an advanced noise reduction system developed by the dbx Corporation.

### The MTS Signal

In order to understand how stereo TV works, let's look at how the entire MTS signal is generated. Then we can see how it is converted back to the original audio information at the stereo TV decoder.

The MTS system used in TV is similar in theory to the familiar FM stereo multiplex system. The multichannel television signal (MTS) consists of the mono channel, stereo subchannel, a second audio channel and a professional audio channel. These channels are combined into a composite audio signal (Figure 2) before modulating the transmitter's audio carrier.

**Mono channel** - The mono (L+R) channel is identical to the monaural signal used in the original NTSC audio format to maintain compatibility with existing monaural only receivers.

**Stereo subchannel** - The stereo (L-R) subchannel (sometimes called the difference channel) carries the stereo (L-R)

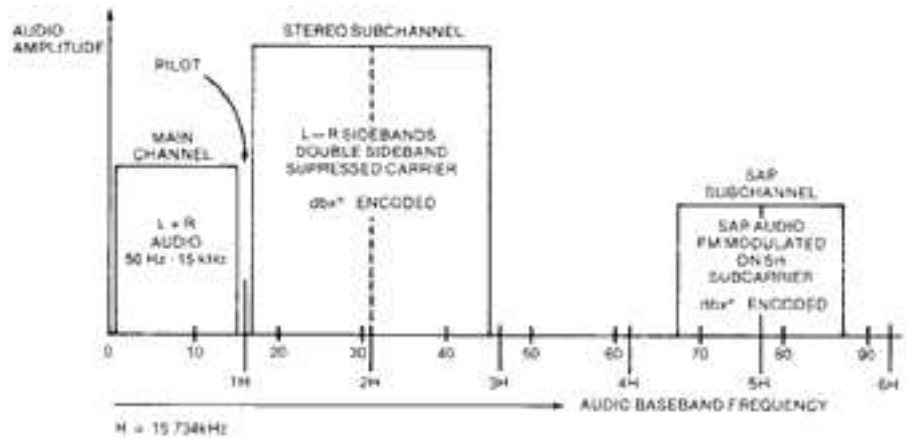

Fig. 3: Content of the MTS composite audio spectrum.

information to recover left and right audio at the receiver. This channel is similar to the stereo (L-R) subchannel used in FM stereo. In the MTS system, however, the (L-R) signal is processed through a noise reduction system.

**Pilot** - The pilot signal at 15,734 Hz is used to tell the receiver that a stereo audio signal is present. It is the reference needed for demodulating the (L-R) information.

**Secondary Audio Program (SAP)** - This channel allows other audio, such as in second language, to be broadcast along with the stereo signal.

**Professional Channel** - This channel is included to transfer telemetry, such as information from remote television crews, back to the production studios. It is not used to transmit broadcast information.

audio signals are summed to form both the left and right audio signals (L+R) and the left and inverted or (- right) audio signals (L-R).

The L+R signal is the main channel audio and occupies the 50 Hz to 15 kHz band. This is the same band as a monaural audio signal. The main L+R audio receives 75 μS preemphasis and deviates the TV's aural carrier +/- 25 kHz. The L+R signal is received by monaural receivers making MTS Stereo compatible with standard TVs.

The L-R signal is the stereo subchannel or the difference channel between the left and right audio information. The L-R signal is produced by inverting the right audio signal (now -R) and adding it to the left audio signal. The difference (L-R) signal is required to separate the left and right audio at the receiver.

### Generating the MTS Signal

The stereo signal begins with separate left and right audio signals. The left and right

The L-R difference signal is first encoded (compressed) by special noise reduction circuitry designed by dbx. The noise reduction system extends the useful range of MTS reception and eliminates receiver

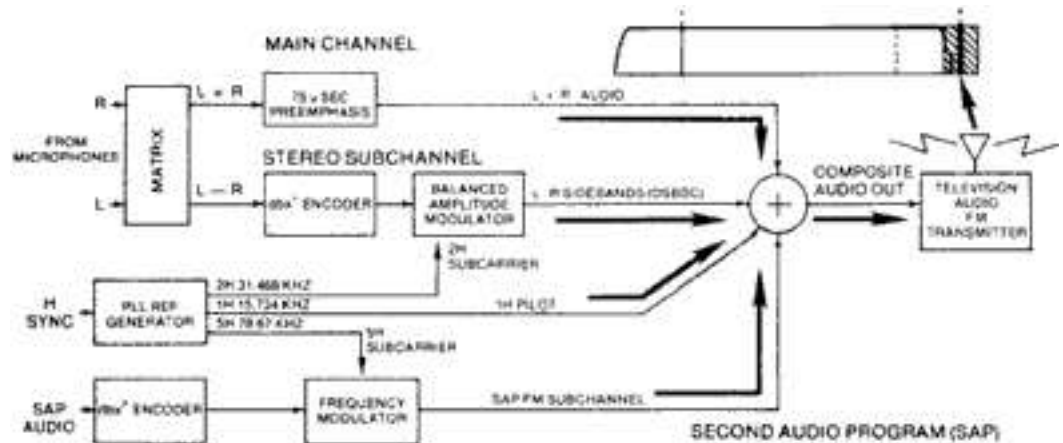

Fig. 4 : The composite MTS audio signal frequency modulates the TV channel's audio carrier.

high frequency noise. The encoded L-R signal then modulates a subcarrier of 31.468 kHz (2H) to produce a double-sideband suppressed-carrier (DSBSC) signal. The L-R sidebands occupy approximately 30 kHz bandwidth centered at 31.468 kHz.

Because the L-R audio information is contained in the sidebands, it is not necessary to transmit the carrier. Eliminating the carrier allows all the transmitter power to be used to transmit the information and reduces interference. At the receiver the carrier must be reinserted to demodulate the L-R information.

The Pilot is needed because the L-R signal is transmitted without a subcarrier in the DSBSC form. The receiver must reinsert a subcarrier frequency of 31.468 kHz to recover the L-R audio. To do this, a sample of the horizontal scan frequency, called the pilot (15.734 kHz) is included in the composite audio signal. The receiver uses the pilot to phase lock a reference oscillator that develops the 31.468 kHz subcarrier needed for L-R demodulation. The pilot signal also tells the receiver that a stereo signal is present.

The stereo and SAP subcarriers were chosen to be multiples of the color TV video horizontal scan frequency so they could be phase locked to the video sync. A phase-locked carrier causes less video interference.

The secondary audio program channel (SAP) carries another audio program such as a second language. The SAP audio is sent through an identical dbx noise reduction systems as the stereo (L-R) subchannel. The SAP signal frequency modulates its 78.671 kHz (5H) subcarrier. The modulating audio has a bandwidth of 50 Hz to 10 kHz.

Finally, a non-program channel is located at 6.5H. This professional channel is used primarily by broadcasters and is not receivable by typical MTS decoder circuits included in receivers.

The composite audio signal (Figure 4) frequency modulates the audio carrier of the TV channel. Because of the relationship of the signals the total FM deviation of the carrier is  $\pm 73$  kHz. The composite audio

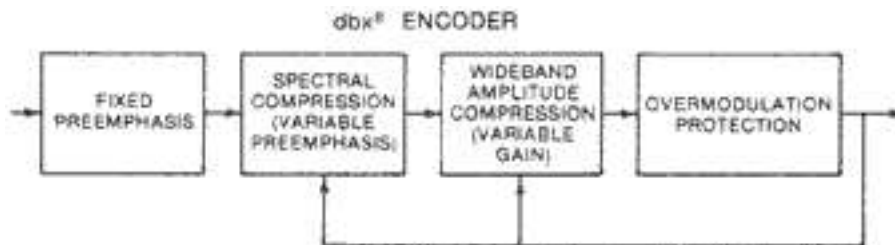

Fig. 5: The stereo subchannel (L-R) and SAP circuits each use noise encoding to reduce the noise level in the audio signals.

information is contained in the sidebands above and below the TV channels audio carrier.

### The MTS dbx Noise Reduction System (Encoding)

The nature of FM transmission systems cause them to have more noise at higher frequencies which limits the quality of the received signal. The L-R subcarrier and SAP subcarrier contain much higher frequencies thus more noise. In the MTS system, background noise increases 3 dB per octave in stereo and 9 dB per octave in SAP. This is the noise that must be masked so there will not be a noticeable increase in receiver noise when switching from mono to stereo reception.

The audio noise reduction scheme used in MTS works on the principle of MASKING. MASKING can be described as making the audio program content loud enough and a broad enough spectrum relative to the system noise to capture the ear's attention.

In MTS, noise is overcome by increasing the modulation level of the L-R subcarrier and "MASKING" the noise with the dbx system. The dbx noise-reduction system encodes the audio information at the transmitter and then the receiver must decode it to recover the original audio. The encoding and decoding is dependent upon the overall amplitude and frequency content of the audio to eliminate the audible background noise. The encode/decode system illustrated in Figure 3, increases the overall signal-to-noise ratio as much as 40 dB.

The dbx encode process is applied to the L-R and SAP signals at the transmitter. The process is not applied to the L+R signal to maintain compatibility with mono receivers. The encoder contains 3 main circuits.

1. Fixed preemphasis
2. Spectral Compressor (variable preemphasis)
3. Wideband Amplitude Compressor

First is the fixed preemphasis circuit which provides a uniform rise per octave in the signal level. Fixed preemphasis boosts the strength of the higher frequencies of the L-R and SAP audio using a 390  $\mu$ S RC time constant curve (Figure 6). A complementary circuit used in the receiver restores the audio to the correct level by deemphasizing the signal. Preemphasis of the high frequencies is the simplest way to mask high frequency noise. Unfortunately, audio program content is not always consistent in frequency and amplitude content so fixed preemphasis alone is not sufficient.

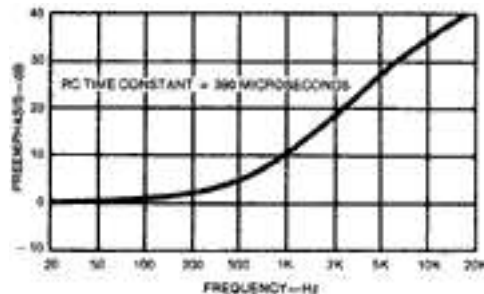

Fig. 6: 390 microsecond fixed preemphasis curve used by dbx encoder in L-R and SAP circuits.

The second part of the dbx encoder is the spectral compressor. Spectral compression is a variable preemphasis based upon the presence of high frequency audio information. With little high-frequency audio program content, the compressor provides a large high frequency preemphasis. With strong high frequency audio program content, the compressor actually provides high frequency attenuation or deemphasis.

The last part of the encoder is the Wideband Amplitude Compressor. Fixed preemphasis and spectral compression do nothing for the overall (average) of the audio program. Therefore noise is more noticeable during quiet portions of the audio program. The wideband amplitude compressor boosts the level of the quiet audio passages and reduces the amplitude of the loud audio passages (Figure 7). The wideband compressor reduces the dynamic range (difference between loudest and quietest audio) by a 2:1 ratio. At the receiver, the decoder reverses the process to restore the audio to its original levels.

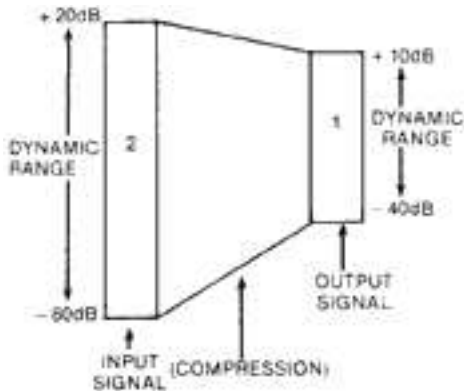

Fig 7 : Wideband Amplitude Compression in the dbx Encoder reduces the amplitude variations of the audio signal by a factor of 2:1.

## The MTS Receiver

In the receiver the modulated RF is converted to a 45.75 Mhz IF signal by the tuner. Two different IF systems are used. In one system the 45.75 MHz IF signal is sent through a single IF section. The aural signal is then converted into a 4.5 MHz signal (Figure 8). The other system is called a split IF because a separate 45.75 MHz IF section is used for the aural signal.

Once the IF signal has been converted to 4.5 MHz it is amplified and demodulated just like it is in a standard TV sound system. The output of the sound demodulator contains the audio baseband signal including the composite audio signal consisting of the L+R, L-R, Pilot, and SAP channels.

The composite audio signal is separated into separate signal paths for processing (Figure 9). One signal path is through a 1H low pass filter. This filter passes only

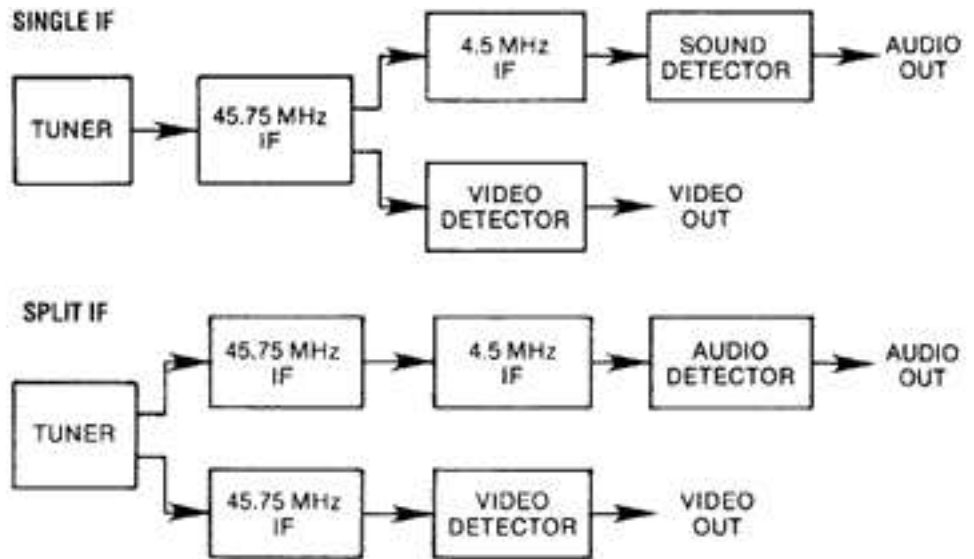

Fig. 8: The IF section of a MTS receiver. Some MTS receivers use a "split IF" where the audio IF is passed by a separate 45.75 MHz IF.

the 50 Hz to 15 kHz signal of the mono (L+R) channel. The mono signal is deemphasized its phase is delayed to match the phase shift introduced into the stereo subchannel (L-R) by the dbx circuits.

The composite audio signal also passes through a 2H filter which passes the L-R subchannel. The stereo subchannel signal is then sent to a balanced demodulator. An oscillator, phase locked to the stereo pilot, demodulates the L-R information.

After demodulation, the L-R signal is sent through a noise reduction decoder and finally to the matrix where is combined with the L+R signal to obtain the separate left and right audio.

A third path for the composite audio signal is through a 5H bandpass filter. This filter passes the Secondary Audio Program (SAP) information. The SAP signal is demodulated and sent on the noise reduction decoder circuits, stereo matrix, audio amps and speaker.

## The MTS dbx Noise Reduction System (Decoding)

At the receiver, the L-R and SAP signals must be dbx decoded to restore the audio to original form. The dbx decoder expands the previously compressed L-R and SAP signals in three steps to reverse the three steps of compression at the transmitter (Figure 10).

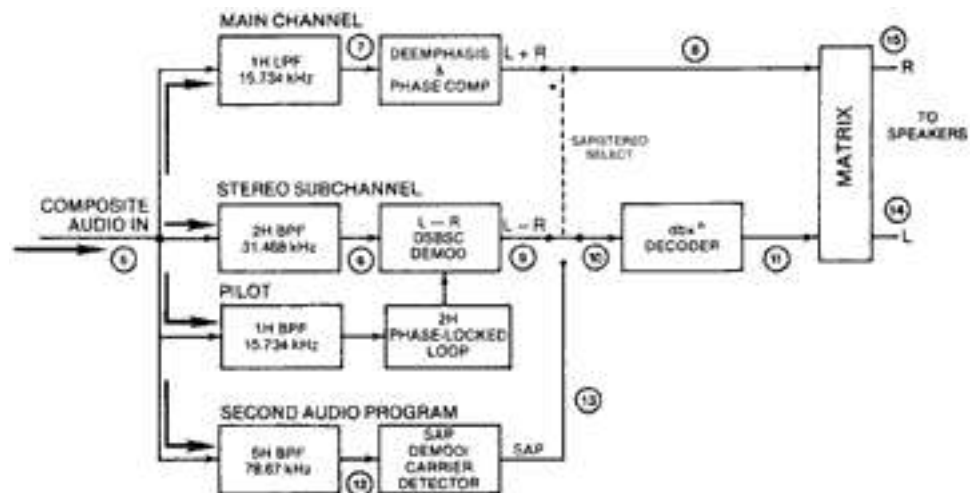

Fig. 9: The MTS receiver processes the main channel, stereo channel and SAP channel separately.

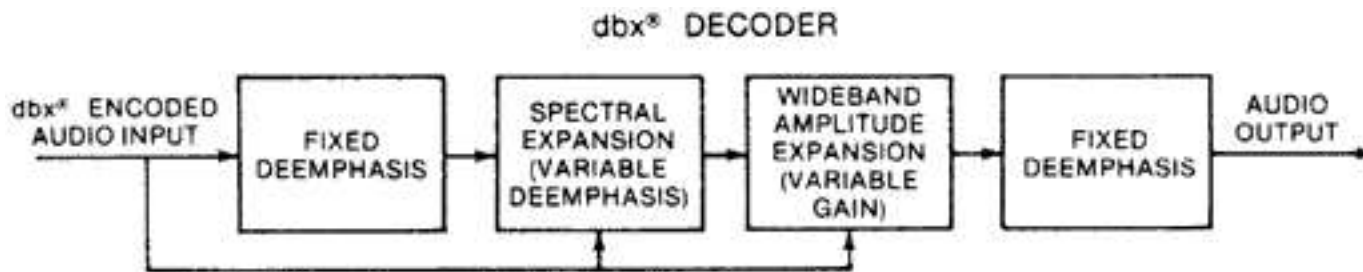

Fig. 10: Receiver dbx deemphasis reverses the action of the preemphasis circuit at the transmitter.

These three steps are:

1. Fixed Deemphasis
2. Spectral Expansion (variable deemphasis)
3. Wideband Amplitude Expansion

The fixed deemphasis circuit has a response curve opposite that of the deemphasis circuits used at the transmitter. High frequency audio is attenuated back to its original level compared to the low frequency audio. At the same time, high frequency noise picked up in the transmission process is attenuated.

Spectral expansion restores the original levels to the high frequency audio signals. Because the transmitter compression process reduces the amount of change in level that normally occurs at high audio frequencies, the receiver expansion process is needed to reverse the process.

When little high frequency information is present at the receiver (the high frequencies are near the same level as noise), the spectral expansion circuit attenuates the signals and the noise. When strong high frequency signals are present, the circuit amplifies them. This reverses the action of the transmitter spectral compression and restores the original dynamic range to the high frequency signals. The benefit of the process is that high frequency audio signals are not allowed to drop to the same level as the system noise.

The wideband expander portion of the dbx decoder restores the signal levels to their proper amplitudes (Figure 11). If the average signal amplitude is high, the decoder boosts the level higher, to its original level. If the signal amplitude is

low, the decoder attenuates it, to its original level. How precisely the decoder action reverses the three encoder actions determines the quality of the reproduced audio.

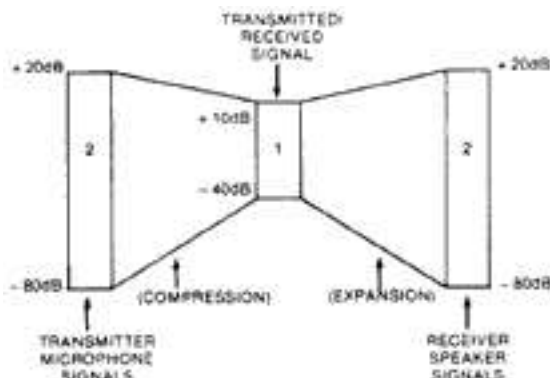

Fig. 11: Compression - Expansion response showing action from the transmitter to the receiver.

# NOTES