

SONY[®]

EI/NTSC

Surveillance and E-Monitoring Systems

General Catalog 2002-2003



INTRODUCTION

Sony Camera, Monitor and Time-Lapse VCR Technologies 2

CAMERAS

Network Cameras 4
 Color CCD Cameras 5
 B/W CCD Cameras 8
 Vari-focal Lens Cameras 9
 Mini Fixed Dome Cameras 9
 UniDome Cameras 10
 Camera Adaptors 11

MONITORS

Color Monitors 12

SURVEILLANCE VIDEO RECORDERS

Digital Time Lapse Video Recorders 14
 Analog Time Lapse Video Recorders 15
 Standard Video Recorders 16

MULTIPLEXERS

Multiplexers 18

PRINTERS

Color Printers 19
 B/W Printers 19

VIDEO NETWORK STATION

Video Network Station 20

SPECIFICATIONS

Network Cameras 22
 Color CCD Cameras 23
 CVX Cameras 24
 B/W CCD Cameras 25
 Vari-focal Lens Camera 26
 Mini Fixed Dome Cameras 27
 Camera Adaptors 28
 Color Monitors 28
 Digital Time Lapse Video Recorders 30
 Analog Time Lapse Video Recorders 31
 Standard Video Recorders 33
 Multiplexers 34
 Printers 35
 Video Network Station 36

SYSTEM EXAMPLES

Cameras: Typical System 37
 Multiplexers: Typical System 39

GLOSSARY

..... 40

INDEX

..... 41

Sony Camera, Monitor and Time-lapse VCR Technologies - The Sony Advantage

Camera technologies

**Exwave HAD™
(SSC-DC50A/DC54A/DC393/M383)**

In monitoring and surveillance applications, camera sensitivity is one of the most important factors in obtaining a clear image in low light conditions.

Exwave Sensitivity

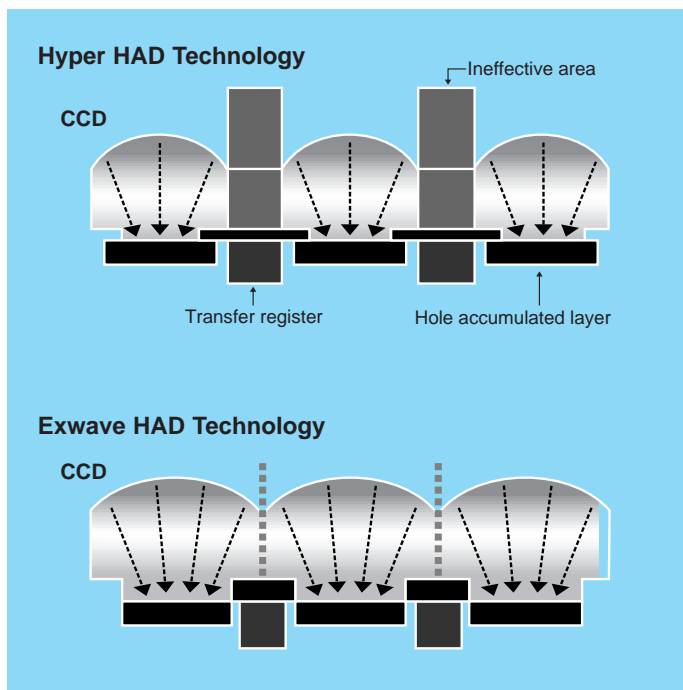

Exwave HAD technology is well over twice that of cameras using the Sony Hyper HAD™ technology. The Hyper HAD sensor structure has an OCL (on chip lens) located over each pixel. This results in light being concentrated on the photosensor areas and the sensitivity of the camera is improved. Exwave HAD technology takes the Hyper HAD technology a giant step further. The OCL of the Exwave HAD is a nearly gapless structure, eliminating the ineffective areas between the microlenses. This enables the hole accumulated layer to receive the maximum amount of light.

In addition, the smear level of the Exwave HAD technology is reduced to 1/50th that of the Hyper HAD technology. This leakage is dramatically reduced because the improvement of the unit cell structure minimizes the unnecessary reflection of the light onto the CCD surface.

**Smart Control™
(SSC-DC50A/DC54A)**

Strong backlighting can often cause the subject of an image to be cast into a shadow. To overcome this problem, the Smart Control function achieves the optimum balance between Iris and Gain settings in a unified digital signal processing circuit. As a result, clear color images can be obtained even under severe or varying lighting conditions. Smart Control also works intelligently as it employs average light metering to detect the position of the major subject, and Fuzzy Logic to calculate the proper exposure.

Backlight Compensation

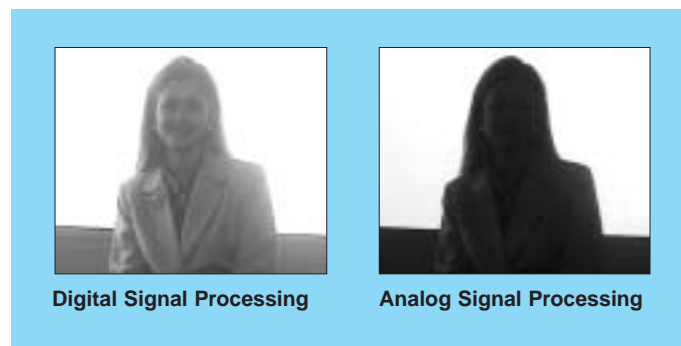

Monitor technology

Trinitron® CRT

Sony incorporates Trinitron CRTs in all of its surveillance color monitors. Sony's Trinitron technology allows for high resolution and the best possible picture reproduction. With its completely flat and straight vertical surface, the Trinitron CRT provides the lowest purity imperfection available in CRT technology today. Moreover, Sony manufactures its own CRTs to assure quality performance in all of its monitors.

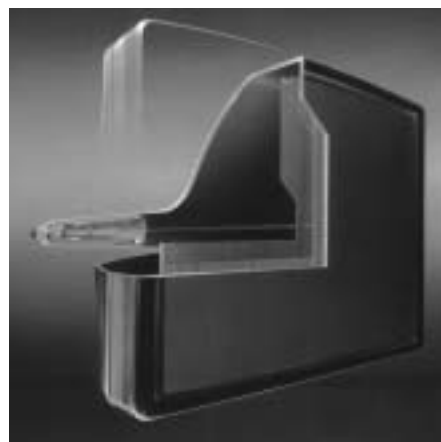

Time-lapse recording technologies

Hybrid Recording (HSR-1/1, HSR-2)

Sony's HSR-1/1 and HSR-2 digital time-lapse recorders use both a hard disk drive (HDD) and a DV (digital video) tape drive for storage. The image data is first recorded onto the HDD and is then transferred to DV tape. This "hybrid" approach to recording has two major advantages. The first advantage is reduced maintenance. Since the DV tape drive works only while recording the image data being transferred from the HDD, the tape transport and heads are stationary most of the time. This significantly reduces the need for head maintenance. The second advantage is multiple protection. In the unlikely event that the DV tape drive fails, recording continues onto the HDD. Conversely, if the HDD fails, recording continues on the DV tape.

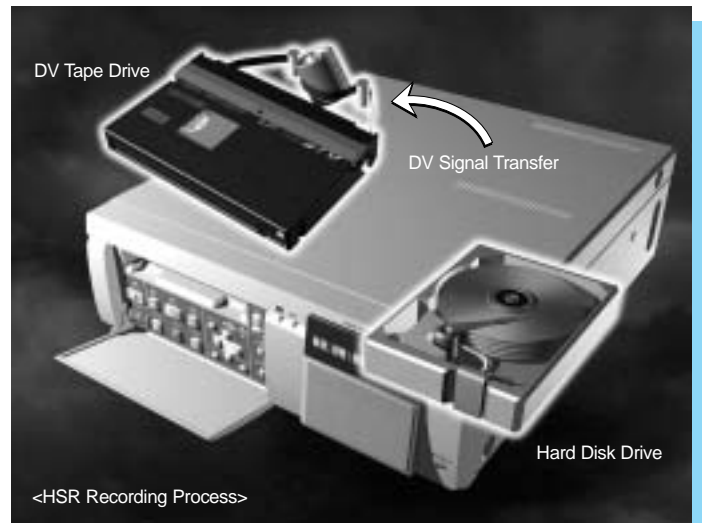

Digital Recording with large capacity HDD (HSR-X200)

Sony's new HSR-X200 is a single channel digital hard disk time-lapse recorder that delivers high quality, detailed images while requiring less maintenance than analog recorders. With the HSR-X200, you get all the benefits associated with a digital format (clear, crisp, undistorted images, fast access to images), plus user-free operation (no tape to rewind, change or pry free and no heads to clean). The HSR-X200 also features long time recording (671 hours at 1 picture/s, HIGH mode) with a high capacity HDD of 80 GB. As an optional accessory, one additional HDD (HSBK-X201, 80 GB) can be installed for doubling the picture capacity or recording time.



RealAction Recording (SVT-RA168/RA40)

Two new Sony time lapse VCRs feature RealAction high density recording. For example, conventional time lapse VCRs record only 5 fields per second in 24 hour recording mode. However, Sony RealAction technology allows recording of 20 fields per second - that's three times as much information. This recording density ensures smooth, natural recording of even fast moving objects.



RealAction recording 20 fields/s



Normal time-lapse recording 5 fields/s

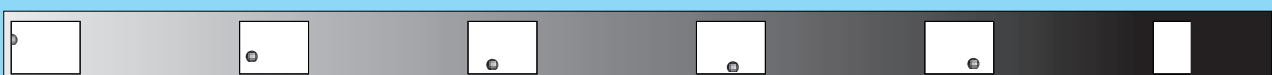

Network Cameras - Remote Monitoring Via the Internet

SNC-VL10N/VL10P



NEW

- IP network color camera for the broadband era
- Remote monitoring from PCs using standard web browsers such as Microsoft® Internet Explorer, Netscape® Navigator and Java Applet-enabled browser
- Various network-connection capabilities (10Base-T Ethernet and USB modem support)
- Easy installation and set-up
- Wavelet image compression format - ideal for network transmission
- Five selectable image sizes per PC - adjust for individual network bandwidth
- Focus-area setting - user can view picture detail without losing the whole image
- Alarm functions including activity detection, one sensor input and two sensor outputs
- High picture quality - 1/3 type IT Super HAD CCD with DSP technology
- High sensitivity - 2.0 lux at F1.4 (50 IRE)
- Horizontal Resolution - 480 lines
- Simultaneous access up to 100 users
- Built-in 2.3x vari-focal lens covers a wide range of viewing angles
- Built-in web server - no special viewer software required
- Analog video output
 - SNC-VL10N: NTSC format
 - SNC-VL10P: PAL format
- RS-232C/485 Transparency Interface for control & operation of external equipment
- CS mount
- Accepts DC servo lens
- CCD IRIS™
- Easy GUI based operation



SNC-VL10N/VL10P Rear

SNC-RZ30N



NEW

- IP network color camera with integrated pan/tilt/zoom
- Ideal for remote monitoring and general IT applications
- Remote monitoring from PCs using a standard web browser such as Microsoft Internet Explorer
- 100 Base-TX /10 Base-T Ethernet
- Simultaneous access up to 50 users
- High-speed and quiet pan/tilt mechanism
- Integral 25x auto-focus zoom lens covers a wide range of viewing angles
- High picture quality - 1/6 type 680,000 pixel IT Super HAD CCD with DSP technology
- High sensitivity - 3.0 lux (color)
- JPEG compression
- Up to 30 frames/s with VGA quality (640 x 480)
- Four selectable image sizes (including 736 x 480)
- NTSC composite video output for local analog viewing or recording
- Image transfer using FTP or SMTP
- Activity detection and alarm trigger functions
- 16 position presets
- Day/Night mode - allows images to be viewed even in low light conditions
- Image stabilizer
- RS-232C/RS-485 transparency interface for control and operation of external equipment
- Two type II PCMCIA expansion slots- support Memory Stick, Flash ATA memory card and ATA HDD card
- Can be ceiling mounted or placed on a flat surface
- Easy GUI based operation



SNC-RZ30N Rear

Color CCD Cameras

SSC-DC393



- Ideal for low light applications
- 1/3 type IT CCD with Exwave HAD technology
- Horizontal resolution - 480 Lines
- Extremely high sensitivity - 0.7 lx at F1.2 (50 IRE)
- Compact and stylish design
- Built-in tripod screw holes for easy installation
- Digital Signal Processing (DSP)
- Sync system: Internal/AC Line Lock
- Backlight compensation: BLC ON/OFF switchable
- Turbo AGC: ON/OFF switchable
- Wide range CCD IRIS (ON/OFF switchable, 1/60 to 1/100,000)
- CCD IRIS function allows for the use of low cost manual iris lenses
- Wide range auto tracking white balance (ATW)
- Accepts video or DC auto iris lenses
- CS mount
- Dual power capability - automatically selects AC 24 V or DC 12 V for proper operation



SSC-DC393 Rear

SSC-DC193



- Ideal for low light applications
- 1/3 type IT CCD with Super HAD™ technology
- Horizontal resolution - 330 Lines
- High sensitivity - 0.6 lx at F1.2, (50 IRE)
- Compact and stylish design
- Built-in tripod screw holes for easy installation
- Digital Signal Processing (DSP)
- Sync system: Internal/AC Line Lock
- Backlight compensation: BLC ON/OFF switchable
- Turbo AGC: ON/OFF switchable
- Wide range CCD IRIS (ON/OFF switchable, 1/60 to 1/100,000)
- CCD IRIS function allows for the use of low cost manual iris lenses
- Wide range auto tracking white balance (ATW)
- Accepts video or DC auto iris lenses
- CS mount
- Dual power capability - automatically selects AC 24 V or DC 12 V for proper operation



SSC-DC193 Rear

SSC-DC593

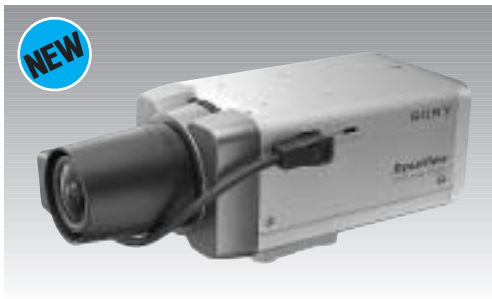

- Ideal for Day/Night surveillance applications
- 1/3 type IT CCD with DynaView™ technology
- Wide dynamic range with DynaView technology - ideal for obtaining clear color images under severe highlight or backlight conditions
- Day/Night mode - increases the camera's sensitivity and allows for use with IR illuminators (Night Mode)
- Horizontal resolution - 480 lines
- High sensitivity - Color: 0.8 lx (F1.4, 50 IRE), B/W (Day/Night mode): 0.07 lx (F1.4, 50 IRE)
- Backlight compensation: DYNAVVIEW/SPOT/WEIGHT/OFF switchable
- White balance: ATW PRO/ATW/3200K/5600K/MANUAL/DUAL WB switchable
- Dual white balance mode - high quality color reproduction of indoor and outdoor scenes under different color temperatures
- Wide range CCD IRIS (1/60 to 1/100,000 s)
- Sync system: Internal/AC Line Lock
- Built-in activity detection and alarm trigger functions
- Privacy Zone Masking function
- Two preset memories for camera setting
- RS-485 Interface for control
- CS mount
- Accepts video or DC auto iris lenses
- Dual power capability - automatically selects AC 24 V or DC 12 V for proper operation



SSC-DC593 Rear

SSC-DC50A/DC54A



- Especially designed for surveillance applications
- 1/2 type IT CCD with Exwave HAD technology
- Horizontal resolution - 470 lines
- Extremely high sensitivity - 0.8 lux at F1.2, 50 IRE
- Low smear level (-120dB)
- Backlight compensation by Smart Control for faster backlight compensation, the detection area can be preset
- Preset Auto Exposure (AE) settings
- Turbo AGC (6 dB more gain than conventional gain): TURBO/NORMAL/OFF switchable
- Aperture/Sharp Mode: SHARP/NORMAL switchable
- ATW PRO/ATW/AWB/preset color temperature settings
- New ATW PRO mode ensures reliable white balance control based on the absolute color temperature of the object (The effective operational color range is 2,500 K to 6,000 K)
- Accepts video or DC auto iris lenses
- C/CS mount
- SSC-DC50A provides single cable operation (video/sync/power triple multiplex transmission) for easy installation with the optional YS-W170/W270 camera adaptor (Mode A)
- SSC-DC50A provides Monitor out function for on-the-spot camera positioning (Mode B)
- Alternative power source operation: DC 12 V for SSC-DC50A, AC 24 V for SSC-DC54A



SSC-DC50A Rear



SSC-DC54A Rear

Color CCD Cameras

CVX-V1



- 1/4 type CCD Color Camera
- Small, thumb-sized and light weight camera head
- Horizontal resolution - 470 lines
- 2 lux minimum illumination
- CCU attaches directly to ZBOX-2 Incident Recorder
- Built-in 3.9 mm F1.8 lens with manual focus and iris
- Variable shutter speed dial on CCU
- AE Lock mode (ON/OFF selectable from CCU)
- Supplied 2 meter cable (6.5 feet) goes between camera head and CCU

CVX-V3



- 1/4 type CCD Color Camera
- 3x manual zoom lens - 3.5 to 10.5 mm F2.8-4.0, fixed focus
- Horizontal resolution - 470 lines
- Built-in stereo microphone
- 5 lux minimum illumination
- Programmed AE modes, selectable from dial on CCU
- Supplied 2 meter cable (6.5 feet) goes between camera head and CCU
- Splash resistant camera head
- CCU attaches directly to ZBOX-2 Incident Recorder (EVO-250 and PGV-250)

CVX-V18NS/SEC



- 1/4 type CCD Color Camera
- Incorporates NightShot™ function which enables recording in 0 lux conditions
- Independent camera head and compact CCU
- CCU attaches directly to the DSR-V10 DVCAM™ Video Walkman or ZBOX-2 Incident Recorder
- Built-in 18x zoom lens
- Manual camera controls via CCU (Focus, Shutter speed, Exposure)
- Date/Time or Title superimposed onto image
- SteadyShot™ function reduces motion shaking
- Long-life lithium-ion battery system

B/W CCD Cameras

SSC-M383



- Ideal for low light applications
- 1/3 type IT CCD with Exwave HAD technology
- Horizontal resolution - 570 Lines
- Extremely high sensitivity - 0.07 lux at F1.2 (50 IRE)
- Compact and stylish design
- Built-in tripod screw holes for easy installation
- Sync system: Internal/AC Line Lock
- Backlight compensation: BLC ON/OFF switchable (when CCD IRIS is ON)
- Turbo AGC (up to 24 dB): ON/OFF switchable
- Wide range CCD IRIS (ON/OFF switchable, 1/60 to 1/100,000)
- CCD IRIS function allows for the use of low cost manual iris lenses
- Accepts video or DC auto iris lenses
- CS mount
- Dual Power Capability - automatically selects AC 24 V or DC 12 V for proper operation



SSC-M383 Rear

SSC-M183



- Ideal for low light applications
- 1/3 type IT CCD with Super HAD technology
- Horizontal resolution - 380 Lines
- Extremely high sensitivity - 0.06 lux at F1.2 (50 IRE)
- Compact and stylish design
- Built-in tripod screw holes for easy installation
- Sync system: Internal/AC Line Lock
- Backlight compensation: BLC ON/OFF switchable (when CCD IRIS is ON)
- Turbo AGC (up to 24 dB): ON/OFF switchable
- Wide range CCD IRIS (ON/OFF switchable, 1/60 to 1/100,000)
- CCD IRIS function allows for the use of low cost iris lenses
- Accepts video or DC auto iris lenses
- CS mount
- Dual Power Capability - automatically selects AC 24 V or DC 12 V for proper operation



SSC-M183 Rear

Vari-focal Lens Cameras

SSC-CX13V, SSC-MX13V



- Built-in auto iris vari-focal lens covers a wide range of viewing areas
- 1/4 type IT Color DSP CCD with Super HAD technology (SSC-CX13V)
- 1/4 type IT B&W CCD with Super HAD technology (SSC-MX13V)
- High resolution and picture quality: 480 TV lines (SSC-CX13V), 570 TV lines (SSC-MX13V)
- High sensitivity of 1.8 lux (SSC-CX13V) and 0.3 lux (SSC-MX13V) at F1.4 (50 IRE, AGC ON)
- Compact and stylish design
- Tripod screw holes for easy installation
- AC line lock capability for AC operation
- Turbo AGC (6 dB more gain than conventional gain): TURBO/NORMAL/OFF switchable
- Backlight compensation: BLC ON/OFF switchable
- ATW (SSC-CX13V)
- Dual Power Capability - automatically selects AC 24 V or DC 12 V for proper operation



SSC-CX13V, SSC-MX13V Rear

Mini Fixed Dome Cameras

SSC-CD53V, SSC-MD53V



- Built-in auto iris focal lens covers a wide range of viewing angles
- 1/4 type IT CCD with Super HAD technology
- High resolution - 480 TV lines (Color model: SSC-CD53V),
- 570 TV lines (B/W model: SSC-MD53V)
- High sensitivity - 2.0 lux (SSC-CD53V) at F1.4 (50 IRE, AGC ON, clear cover)
- 0.4 lux (SSC-MD53V) at F1.4 (50 IRE, AGC ON, clear cover)
- Rugged design - IP66 rated
- Dual Power Capability - automatically selects AC 24 V or DC 12 V for proper operation
- Designed for easy mounting and installation
- AC line lock capability for AC operation
- Turbo AGC (6 dB more gain than conventional gain): TURBO/NORMAL/OFF switchable
- Backlight compensation: BLC ON/OFF switchable
- ATW (SSC-CD53V)
- Optional accessories: Clear dome cover (YT-LDC53 V)
In-ceiling bracket (YT-ICB53 V)

SSC-CD33V, SSC-MD33V



- Built-in auto iris focal lens covers a wide range of viewing angles
- 1/4 type IT CCD with Super HAD technology
- High resolution - 480 TV lines (Color model: SSC-CD33V)
- 570 TV lines (B/W model: SSC-MD33V)
- High sensitivity - 2.0 lux (SSC-CD33V) at F1.4 (50 IRE, AGC ON, clear cover)
- 0.4 lux at F1.4 (50 IRE, AGC ON, clear cover)
- Dual Power Capability - automatically selects AC 24 V or DC 12 V for proper operation
- Designed for easy mounting and installation
- AC line lock capability for AC operation
- Turbo AGC (6 dB more gain than conventional gain): TURBO/NORMAL/OFF switchable
- Backlight compensation: BLC ON/OFF switchable
- ATW (SSC-CD33V)
- Optional accessories: Clear dome cover (YT-LDC33 V)
In-ceiling bracket (YT-ICB33 V)

UniDome Cameras**UNI-DN25S0/UNI-DN25FI**

- Sony Day/Night Color Camera w/ integrated 25X Optical Zoom and 12X Digital Zoom
UNI-DN25S0 - 7" Outdoor UniDome Camera w/ Clear Lower Dome
UNI-DN25FI - 6" Indoor UniDome Camera w/ Smoked Lower Dome and Flush Mount Kit
- 1/6 type 680,000 pixel Super HAD™ CCD
- 0 Lux Shot Mode capability (when used with IR illuminators)
- High Resolution - More than 470 TV lines
- Image stabilizer function compensates for camera vibration
- Excellent Sensitivity –
Color - 3.0 Lux @ F1.6 (50 IRE)
B/W - 0.16 Lux @ F1.6 (50IRE)
- Quick Release mechanism for easy installation and service
- 64 presets at speeds of up to 400° per second
- Up to 4 camera tours including 2 Uni-Tours

UNI-D18SI/UNI-D18FI

- Sony Indoor Color Camera w/ integrated 18X Optical Zoom and 4X Digital Zoom
UNI-D18SI - 6" Indoor Surface Mount UniDome Camera w/ Smoked Lower Dome
UNI-D18FI - 6" Indoor Flush Mount UniDome Camera w/ Smoked Lower Dome
- 1/4 type SuperHAD™ CCD for superb color sensitivity
- Excellent Sensitivity –1.0 Lux @ F1.4 (50 IRE)
- High Resolution - More than 470 TV lines
- 360° Continuous pan
- Integrated RS-422 receiver for twisted pair control
- Quick Release mechanism for easy installation and service
- Variable speed manual control via UNI-TCTL1 (1° to 80° per second)
- 32 presets at speeds of up to 400° per second
- Uni-Tour Feature - Memorizes camera & zoom movements for up to 240 seconds

Camera Adaptors

YS-W270



- Camera adaptor for SSC-DC50A Color CCD Camera
- Transmits DC power and video/sync signal between the adaptor and SSC-DC50A camera over a single coaxial cable
- Up to four SSC-DC50A cameras can be connected
- Internal or external synchronization with MPX-VS or MPX-VD
- Maximum cable length: 600 m with RG-11A/U (7C-2V) coaxial cable



YS-W270 Rear

YS-W170



- Camera adaptor for SSC-DC50A Color CCD Camera
- Transmits DC power and video/sync signal between the adaptor and SSC-DC50A camera over a single coaxial cable
- Internal or external synchronization with MPX-VS or MPX-VD
- Maximum cable length: 600 m with RG-11A/U (7C-2V) coaxial cable



YS-W170 Rear

Color Monitors

SSM-14N5U



- 14-inch Trinitron color monitor
- Horizontal resolution - over 500 TV Lines
- Accepts NTSC, PAL, SECAM and NTSC4.43
- Automatic beam current feedback for stable white balance
- Loop-through Composite and Y/C inputs with 75 Ω automatic termination
- On-screen menu operation available in five languages
- EIA standard rack mount capability with optional MB14N1U rack kit
- Metal cabinet for high immunity to external electrical and magnetic interference
- Built-in speaker for audio monitoring



SSM-14N5U Rear

SSM-20N5U



- 20-inch Trinitron color monitor
- Horizontal resolution - over 500 TV Lines
- Accepts NTSC, PAL, SECAM and NTSC4.43
- Automatic beam current feedback for stable white balance
- Loop-through Composite and Y/C inputs with 75 Ω automatic termination
- On-screen menu operation available in five languages
- EIA standard rack mount capability with optional MB20NU rack kit or SLR-103A slide rail kit
- Metal cabinet for high immunity to external electrical and magnetic interference
- Built-in speaker for audio monitoring



SSM-20N5U Rear

PVM-14N6U



- 14-inch Trinitron color monitor
- Horizontal resolution - over 500 TV Lines
- Automatic beam current feedback circuit for stable color balance
- Accepts Composite video, Y/C and RGB signals
- Switchable aspect ratio (4:3 and 16:9)
- On-screen menu for adjustment/operation
- Input channel can be selected via REMOTE terminal (Phono)
- Built-in speaker
- One touch recall of last menu used (VOLUME, CONTRAST, BRIGHTNESS, CHROMA and PHASE)
- Mountable into a 19-inch EIA standard rack with the optional MB-502B and SLR-102 slide rail kit



PVM-14N6U Rear

PVM-20N6U



- 20-inch Trinitron color monitor
- Horizontal resolution - 500 TV Lines
- Automatic beam current feedback circuit for stable color balance
- Accepts Composite video, Y/C and RGB signals
- Switchable aspect ratio (4:3 and 16:9)
- On-screen menu for adjustment/operation
- Input channel can be selected via REMOTE terminal (Phono)
- Built-in speaker
- One touch recall of last menu used (VOLUME, CONTRAST, BRIGHTNESS, CHROMA and PHASE)
- Mountable into a 19-inch EIA standard rack with the optional SLR-103A slide rail kit



PVM-20N6U Rear

Color Monitors

PVM-8045Q



- 8-inch (viewable area) Trinitron color monitor
- Switchable aspect ratio (4:3 and 16:9) with the 16:9 button on the front panel
- High resolution CRT - 450 TV Lines at center (composite video)
- Beam current feedback circuit for stable color balance
- Analog component level selectable between BETA and SMPTE/N10 by a rear panel slide switch
- NTSC comb filter
- Accepts external sync/sync on Green
- Tally input
- Color temperature D65
- Blue Only, H/V delay, Underscan capability
- Built-in speaker and monitoring amplifier
- AC/DC operation
- Front panel degauss button
- EIA standard rack mountable with a second PVM-8045Q (or an optional Mounting Panel MB-509) by using the optional Mounting Bracket MB-520



PVM-8045Q Rear

PVM-8042Q



- 8-inch (viewable area) Trinitron color monitor
- Switchable aspect ratio (4:3 and 16:9) with the 16:9 button on the front panel
- Beam current feedback circuit for stable color balance
- Analog component level selectable between BETA and SMPTE/N10 by a rear panel slide switch
- NTSC comb filter
- Accepts external sync/sync on Green
- Tally input
- Color temperature D65
- Blue Only, H/V delay, Underscan capability
- Built-in speaker and monitoring amplifier
- AC/DC operation
- Front panel degauss button
- EIA standard rack mountable with a second PVM-8042Q (or an optional Mounting Panel MB-509) by using the optional Mounting Bracket MB-520

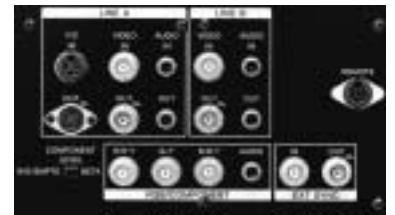

PVM-8042Q Rear

PVM-8040



- 8-inch (viewable area) Trinitron color monitor
- Beam current feedback circuit for stable color balance
- Composite video or Y/C input with audio input
- Built-in speaker
- 19-inch EIA standard rack mountable with a second PVM-8040 (or an optional Mounting Panel MB-509) by using the optional Mounting Bracket MB-520

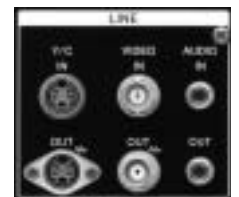

PVM-8040 Rear

Digital Time Lapse Video Recorders

HSR-X200



- Single Channel Digital Hard Disc Recorder
- 80 GB Hard Drive (ATA/ATAPI-5 standard) - expandable to 160 GB
- Recording time of 671 hours at 1 fps, high mode
- Compatible with most existing multiplexers
- Real time OS (operating system) for increased reliability
- High-resolution & high picture quality recording and playback (Field & Frame recording)
- Motion JPEG compression
- Network capability with optional LAN card (IN101-AF)
- Data backup function with optional SCSI card and DDS
- Image transfer to Memory Stick, Compact Flash or Micro Drives with a PC Card Adaptor
- Activity detection sensor/search - recognizes changes in luminance
- Digital zoom function (2x zoom)
- Easy operation with Jog/Shuttle and independent operation buttons
- RS-232C/485 interface for PC control
- HDD mirroring function
- Audio single channel recording and playback
- Various languages (English/French/Spanish/German)

Optional accessory: Expansion HDD HSBK-X201



HSR-X200 Rear

HSR-1/1, HSR-2



- Hybrid digital recorder for high performance digital video recording and archiving
- Playback during recording offers greater flexibility in providing access to the information without stopping the recording (HSR-2 only)
- 20 GB HDD offers high storage capacity for immediate access to the information recorded onto the HDD (HSR-2 only)
- High resolution - over 500 TV Lines (Super mode)
- Excellent S/N of 48 dB
- Large storage capacity - 60 GB using DV 270 tape
- High reliability and low maintenance utilizing hybrid configuration of hard disk and DV tape drive
- Built-in 4 input multiplexer board - field upgrade capable to 16 inputs using 3 additional 4 input cards, HSRA-11
- Time/date and alarm event search capabilities
- Excellent backup features - writes to DV in case of HDD failure or vice versa
- Continuous recording function without breaks even while changing or rewinding tapes
- High refresh rate recording of each camera
- Two monitoring outputs for simultaneous playback on the first monitor and monitoring on the second monitor
- RS-232C interface for PC control
- Pre Alarm recording capability for event recording
- Full control of HSR-1/1 and HSR-2 over a network when used with Sony's SNT-V304 Video Network Station



HSR-1/1, HSR-2 Rear

Analog Time Lapse Video Recorders

SVT-RA168



- Quality recording and playback for those critical moments
- Incorporates Sony's 'RealAction' technology for high density recording of 20 fields per second
- Maximum 168-hour time lapse recording is available with a T-120 tape
- Maximum 224-hour time lapse recording is available with a T-160 tape
- Six different time lapse recording/playback modes
- Adaptive Picture Control (APC) records clear images even after long periods of use
- Audio recording and playback in 8, 24, 40 hour modes
- Rapid fast-forward and rewind: 100 seconds with an entire T-160 tape
- RS-232C/485 interface with the optional SVT-RS100 interface board
- Built-in time/date generator, 30-day battery backup
- Multiple recording modes such as Auto Repeat Recording, Timer Recording, Alarm Recording and Series Recording
- Record check, alarm data list, alarm scan capabilities
- Camera switcher/multiplexer interface
- Field advance/reverse playback capability
- Tape before-end signal output capability
- Warning signal output capability
- Video loss alarm capability
- Remote control capability of basic operational functions through ϕ 3.5 mm mini jack

Optional accessory:
 Remote control unit SVT-RM10
 Interface board SVT-RS100



SVT-RA168 Rear

SVT-RA40



- Quality recording and playback for those critical moments
- Incorporates Sony's 'RealAction' technology for high density recording of 20 fields per second
- Maximum 30-hour time lapse recording is available with a T-120 tape
- Maximum 40-hour time lapse recording is available with a T-160 tape
- Two different time lapse recording/playback modes
- Adaptive Picture Control (APC) records clear images even after long periods of use
- Audio recording and playback in 8, 24, 40 hour modes
- Rapid fast-forward and rewind: 100 seconds with an entire T-160 tape
- RS-232C/485 interface with the optional SVT-RS100 interface board
- Built-in time/date generator, 30-day battery backup
- Multiple recording modes such as Auto Repeat Recording, Timer Recording, Alarm Recording and Series Recording
- Record check, alarm data list, alarm scan capabilities
- Field advance/reverse playback capability
- Tape before-end signal output capability
- Warning signal output capability
- Video loss alarm capability
- Remote control capability of basic operational functions through ϕ 3.5 mm mini jack

Optional accessory:
 Remote control unit SVT-RM10
 Interface board SVT-RS100



SVT-RA40 Rear

Analog Time Lapse Video Recorder

SVT-124



- 2, 12, 24 hour recording/playback modes (T-120)
- Compact size - only 240 mm (9 1/2") wide
- Adaptive Picture Control (APC)
- Audio recording in 2, 12 or 24 hour modes
- Built-in time and date generator, 30 day battery backup
- Auto repeat and timer recording capabilities
- Alarm recording from Stop or Power Off modes
- Record check, alarm log, alarm scan capabilities
- Remote control capability of basic operational functions through ϕ 3.5 mm mini jack

Optional accessories: Remote control unit SVT-RM10

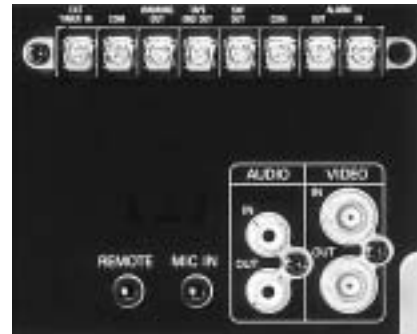

SVT-124 Rear

Standard Video Recorders

SVO-1330



- Professional VHS Videocassette Recorder/Player
- Ideal for casino surveillance applications where a number of VCRs are used for continuous recording
- High resolution and excellent color reproduction due to HQ circuitry and Double Azimuth PRO 4-head design
- APC (Adaptive Picture Control) optimizes both recording and playback
- Clock adjustment terminals allow clocks of multiple VCRs to be adjusted simultaneously
- Eject terminals allow videocassettes of multiple VCRs to be ejected simultaneously
- Timer, Series and SP/EP recording
- Frame by frame playback (forward only)
- Memory back-up function for up to 30 days
- Auto head cleaner

Optional accessories: Remote Control Unit SVT-RM10



SVO-1330 Rear

Standard Video Recorders

EVO-250



- Hi8 Video recorder designed for mobile and covert applications
- Horizontal resolution - over 400 Lines
- Compact and light weight
- Long battery operation (over 9 hours using NP-F960) with adoption of Lithium ion battery system
- Direct attachment interface with the PGV-250 program unit
- 5 head system for high quality SP/LP mode recording
- LaserLink™ system for wireless IR transmission of A/V signals
- Supplied with DC-V700 DC pack/car battery adaptor
- Built-in time base corrector reduces jitter during playback
- Digital Noise Reducer digitally reduces chroma noise on playback

PGV-250



- Incident Recorder Adaptor
- Direct interface to EVO-250
- Built-in time/date generator superimposed to incoming video
- Composite or Y/C inputs
- Program Record mode allows flexible alarm handling recording for the EVO-250
- 2 channel Hi-Fi audio recording capabilities
- Accepts microphone or line level audio inputs
- Flexible alarm handling and timer capabilities

Optional accessories:

AC-SQ950D AC/DC Adaptor and Charger

NP-F550 Rechargeable Battery Pack

NP-F750 Rechargeable Battery Pack

NP-F960 Rechargeable Battery Pack

Multiplexers

YS-DX516/DX416



- Full duplex video multiplexer that supports up to 16 camera inputs
YS-DX516: Color
YS-DX416: B/W
- Multiplex recording to one VCR while switching between each camera by a field for precise surveillance of multiple points
- Live pictures can be displayed in full screen, sequence, quad and multi-screen (4/9/16) while simultaneously recording
- Playback can be reviewed in full screen, sequence, and multi-screen (4/9/16)
- Individual sequence dwell time
- Individual alarm duration/output
- Activity detection
- Video loss alarm
- Alarm duration: The alarm duration of each video camera can be programmed individually
- Monitor masking for specific cameras
- RS-232C/RS-485 compatible
- Menu: English/French/Spanish

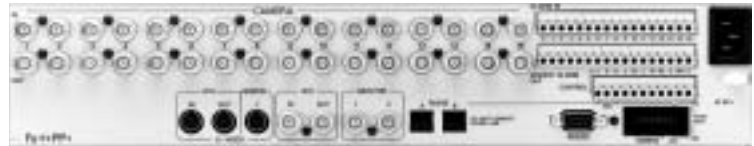

YS-DX516 Rear

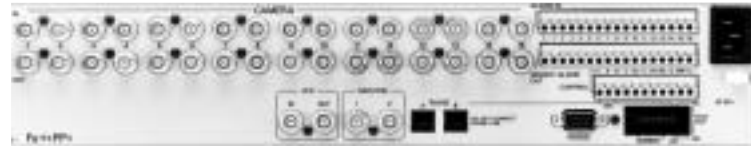

YS-DX416 Rear

YS-DX504



- Half duplex color video multiplexer that supports up to 4 cameras
- Multiplexing recording to one VCR while switching between each camera by a field for precise surveillance of multiple points
- Live images can be displayed in full screen, sequence and quad while simultaneously recording
- Playback can be reviewed in full screen, sequence and quad
- Zoom and Freeze functions are available in full screen and quad
- Individual sequence dwell time
- Individual alarm duration/output
- Activity detection
- Video loss alarm
- Alarm duration: The alarm duration of each video camera can be set individually
- RS-232C compatible
- Menu: English/French/Spanish



YS-DX504 Rear

Color Video Printer**UP-20**

- Near A6 size dye sublimation color printer
- High speed printing - 16 seconds in high speed mode
- Excellent print quality and color reproduction - approximately 400 dpi resolution
- Four frame memory
- Y/C and analog inputs and outputs
- 2 or 4 split image print mode
- Monitor loop through for system saving power
- Worldwide power and video capability
- RS-232C interface

B/W Printer**UP-960**

- Thermal video graphic printer with 256 steps of gradation grey level
- Large print size of 190 x 143 mm in standard mode
- High speed printing of approx. 10 seconds in standard mode
- Approx. 124 prints out of UPP-210HD/210SE (25 m)
- Frame/Field memory selectable
- Printing direction selectable: Standard/Side/Reverse
- Positive/Negative printing
- Normal/Wide 1/Wide 2 scan selectable
- 4:3/1:1 aspect ratio selectable
- EIA/CCIR automatic selection
- Multiple copy function

SNT-V304



- Ideal for video monitoring over networks
- Enables up to four video surveillance cameras to be remotely monitored and controlled over existing networks (LAN, WAN, telephone lines)
- GUI based monitoring and control using networked PCs utilizing standard web browser
- Easy to install, expand and maintain
- Multi-user access and password protection
- High refresh rates provide near-motion pictures
- S-Video input or video input 1
- Remote camera/HSR1/1 or HSR-2 recorder control
- Alarm image buffering allows for storage of pre-alarm and post-alarm images
- When an alarm occurs a JPEG file showing the alarm event can be sent to a pre-determined e-mail address or server
- TCP/IP, 100 Base-TX/10 Base-T interface
- Image update to FTP server
- Relay out control



SNT-V304 Rear

MODEL SPECIFICATIONS

SPECIFICATIONS

Network Cameras

	SNC-VL10N	SNC-VL10P	SNC-RZ30N
CPU	32-bit RISC-Embedded processor	32-bit RISC-Embedded processor	32-bit RISC processor
Flash memory	8 MB (Default home page area: 4.5 MB)	8 MB (Default home page area: 4.5 MB)	8 MB
RAM	16 MB (Free area 6 MB)	16 MB (Free area 6 MB)	32 MB (includes 8 MB alarm buffer)
OS (client PC)	Microsoft Windows 98/Me/NT/2000, Macintosh®, UNIX, Linux®	Microsoft Windows 98/Me/NT/2000, Macintosh, UNIX, Linux	Microsoft Windows 98/Me/NT4.0/2000/XP
Web browser	Microsoft Internet Explorer version 5.0, 5.5 or 6.0, Netscape Navigator version 4.7 or 6.0, Java Applet-enabled browser	Microsoft Internet Explorer version 5.0, 5.5 or 6.0, Netscape Navigator version 4.7 or 6.0, Java Applet-enabled browser	Microsoft Internet Explorer version 5.5 or 6.0
Protocols	TCP/IP, HTTP, ARP, RARP, ICMP, DHCP, PPP, PPPoE, FTP, SMTP, and SNMP	TCP/IP, HTTP, ARP, RARP, ICMP, DHCP, PPP, PPPoE, FTP, SMTP, and SNMP	DHCP, TCP/IP, HTTP, ARP, FTP, ICMP and SNMP
Image compression Algorithm Rate	Wavelet 10:1 to 200:1 (10 steps)	Wavelet 10:1 to 200:1 (10 steps)	JPEG 1/5 to 1/60 (10 steps)
Performance Frame rate Local compression rate	30 f/s (360 x 243) Max. 30 f/s	25 f/s (360 x 288) Max. 25 f/s	Max. 30 f/s (640 x 480)
Security	Password-based user authentication IP-filtering (Secure Mode) Image encryption	Password-based user authentication IP-filtering (Secure Mode) Image encryption	Password protection IP-filtering
Pickup device	1/3 type Interline Transfer Super HAD CCD	1/3 type Interline Transfer Super HAD CCD	1/6 type Interline Transfer Super HAD CCD
Pic. Elements (HxV)	768 x 494	752 x 582	680,000
Image size (HxV)	720 x 486, 720 x 243, 360 x 243, 180 x 121, 90 x 60	720 x 576, 720 x 288, 360 x 288, 180 x 144, 90 x 72	736 x 480, 640 x 480, 320 x 240, 160 x 120
Built-in lens	Vari-focal (focal length: 3.5 to 8.0 mm)	Vari-focal (focal length: 3.5 to 8.0 mm)	25x zoom (focal length: 2.4 mm to 60 mm)
View angle	W= 73.9 ° (H), 56.3 ° (V) T= 33.8 ° (H), 25.8 ° (V)	W= 73.9 ° (H), 56.3 ° (V) T= 33.8 ° (H), 25.8 ° (V)	2 to 45 degrees
Iris	Manual (F1.4 to close)	Manual (F1.4 to close)	Auto/Manual (F1.6 to close)
Minimum object distance	0.5 m	0.5 m	W = 30 mm, T = 800 mm
Lens mount	CS	CS	–
White balance	ATW	ATW	Auto, ATW, Indoor, Outdoor, One-push (trigger, command), Manual
Focus	Manual	Manual	Auto/Manual (Near, Far, One-push autofocus)
Electronic shutter	1/60 to 1/100,000 s (CCD IRIS)	1/50 to 1/100,000 s (CCD IRIS)	1/4 s to 1/10000 s
Gain	Auto	Auto	Auto/Manual (-3 dB to +28 dB)
Exposure	Full Auto	Full Auto	Auto [Full Auto (including Backlight compensation), Shutter-priority, Iris-priority], Manual
EV compensation	–	–	-1.75 to +1.75 (15 steps)
Pan angle	–	–	-170 degrees to +170 degrees
Tilt angle	–	–	-90 degrees to +25 degrees
Analog video output Signal system Sync system Horizontal resolution S/N ratio Minimum illumination	NTSC Internal 480 TV lines Better than 50 dB 2.0 lx	PAL Internal 480 TV lines Better than 50 dB 2.0 lx	NTSC Internal 480 TV lines Better than 48 dB 3.0 lx (color)
I/F and I/O	Analog composite video out (BNC x 1) DC 12 V 10 BASE-T Ethernet USB modem RS-232C/485 (transparency only) Sensor I/O Volume for video level Lens (DC servo)	Analog composite video out (BNC x 1) DC 12 V 10 BASE-T Ethernet USB modem RS-232C/485 (transparency only) Sensor I/O Volume for video level Lens (DC servo)	Analog composite video out (BNC x 1) 100 Base-TX/10 Base-T Ethernet (RJ-45 x 1) PCMCIA Type II (2) Sensor in (3), Alarm out (2), RS-232C/485 (transparency only, x1)
Operating temperature	-10 to +50 °C (14 to 122 °F)	-10 to +50 °C (14 to 122 °F)	0 to 40 °C (32 °F to 104 °F)
Storage temperature	-40 to +60 °C (-40 to 140 °F)	-40 to +60 °C (-40 to 140 °F)	-20 to +60 °C (-4 °F to +140 °F)
Power requirement	DC 12 V via AC adaptor (100 to 240 V) Ethernet Hub/switching equipment for in-line power, IEEE802.3af	DC 12 V via AC adaptor (100 to 240 V) Ethernet Hub/switching equipment for in-line power, IEEE802.3af	DC 12 V via AC adaptor (100 V to 240 V)
Power consumption	6.8 W (DC 12 V)	6.8 W (DC 12 V)	21.6 W (with ATA HDD card)
Mass	350 g (12 oz)	350 g (12 oz)	1.2 kg (2 lb 10 oz)
Dimension (WxHxD), mm (inches)	96 x 63 x 186 (3 7/8" x 2 1/2" x 7 3/8")	96 x 63 x 186 (3 7/8" x 2 1/2" x 7 3/8")	140 x 175 x 144 (5 5/8" x 7 x 5 3/4")

Color CCD Cameras

	SSC-DC393	SSC-DC193	SSC-DC593	SSC-DC50A	SSC-DC54A
Pickup device	1/3 type Interline Transfer CCD with Exwave HAD technology	1/3 type Interline Transfer Super HAD CCD	1/3 type Interline Transfer CCD with DynaView technology	1/2 type Interline Transfer CCD with Exwave HAD technology	1/2 type Interline Transfer CCD with Exwave HAD technology
Pic. Elements (HxV)	768 x 494	510 x 492	768 x 494	768 x 494	768 x 494
Lens mount	CS	CS	CS	C & CS adj	C & CS adj
Signal system	NTSC	NTSC	NTSC	NTSC	NTSC
White balance	ATW	ATW	ATW PRO/ATW/ 3200K/5600K/MANUAL/DUAL WB	ATW PRO/ATW/AWB/ PRESET 5600 K	ATW PRO/ATW/AWB/ PRESET 5600 K
Sync system	Internal/External	Internal/External	Internal/External	Internal/External	Internal/External
External sync	AC Line Lock (for AC 24 V)	AC Line Lock (for AC 24 V)	AC Line Lock (for AC 24 V)	VS and VBS/MPX VS	AC Line Lock (for AC 24 V) VS and VBS
V-phase control	±90°	±90 °	±90 °	—	±90°
H-Phase control	—	—	—	Yes	Yes
Horizontal resolution	480 Lines	330 Lines	480 Lines	470 Lines	470 Lines
S/N Ratio (AGC OFF, Weight ON)	Better than 50 dB	Better than 50 dB	Better than 50 dB	Better than 50 dB	Better than 50 dB
Min. illumination (Turbo AGC ON)	0.35 lx at F1.2 (30 IRE) 0.7 lx at F1.2 (50 IRE) 3.5 lx at F1.2 (100 IRE)	0.3 lx at F1.2 (30 IRE) 0.6 lx at F1.2 (50 IRE) 3.0 lx at F1.2 (100 IRE)	Color: 0.8 lx at F1.4 (50 IRE) B/W: 0.07 lx at F1.4 (50 IRE)	0.4 lx at F1.2 (30 IRE) 0.8 lx at F1.2 (50 IRE)	0.4 lx at F1.2 (30 IRE) 0.8 lx at F1.2 (50 IRE)
Backlight compensation	—	—	DYNAVIEW/SPOT/WEIGHT/OFF switchable	—	—
Day/night mode	—	—	COLOR/AUTO/EXTERNAL/B&W switchable		
Video output	1.0 Vp-p, BNC (1)	1.0 Vp-p, BNC (1)	1.0 Vp-p, BNC (1)	Composite, BNC (1) Y/C, Mini-Din (1)	Composite, BNC (1) Y/C, Mini-Din (1)
Operating temperature	-10 to 50 °C (14 to 122 °F)	-10 to 50 °C (14 to 122 °F)	-10 to 50 °C (14 to 122 °F)	-10 to 50 °C (14 to 122 °F)	-10 to 50 °C (14 to 122 °F)
Storage temperature	-40 to 60 °C (-40 to 140 °F)	-40 to 60 °C (-40 to 140 °F)	-40 to 60 °C (-40 to 140 °F)	-40 to 60 °C (-40 to 140 °F)	-40 to 60 °C (-40 to 140 °F)
Power requirements	AC 24 V, 60 Hz / DC 12 V	AC 24 V, 60 Hz / DC 12 V	AC 24 V, 60 Hz / DC12 V	1) Multiplexing with YS-W170/W270 2) DC 12 V from DC 12 V power supply	AC 24 V, 60 Hz
Power consumption	3.7 W	3.5 W	5.8 W	1) 5.5 W supplied from YS-W170/W270 2) 4.5 W at DC 12 V	6.0 W
Mass	360 g (13 oz)	360 g (13 oz)	500 g (1 lb 2 oz)	600 g (1 lb 5 oz)	600 g (1 lb 5 oz)
Dimensions (WxHxD), mm (inches)	60 x 54 x 120 (2 3/8" x 2 1/4" x 4 3/4")	60 x 54 x 120 (2 3/8" x 2 1/4" x 4 3/4")	70 x 57 x 129 (2 7/8" x 2 1/4" x 5 1/8")	64 x 57 x 137 (2 1/2" x 2 1/4" x 5 3/8")	64 x 57 x 137 (2 1/2" x 2 1/4" x 5 3/8")

SPECIFICATIONS

CVX Cameras

	CVX-V1	CVX-V3	CVX-V18NS
Pickup device	1/4 type IT CCD	1/4 type IT CCD	1/4 type IT CCD
Picture elements (total)	410,000 pixels	470,000 pixels	470,000 pixels
Signal system	EIA/NTSC color	EIA/NTSC color	EIA/NTSC color
Lens	3.9mm F1.8	3.4 - 10.2mm F2.8-4.0	4.1 - 73.8mm F1.4-2.9
Minimum illumination	6 lux	6 lux	0.7 lux (25IRE)
Recommended illumination	more than 100 lux	more than 100 lux	more than 100 lux
Video output	Composite Video, RCA X1 Y/C, Mini-DIN 4 pin	Composite Video, RCAX1 Y/C, Mini-DIN 4 pin	Composite Video, RCAX1 (onCCU) Y/C, Mini-DIN 4 pin
Audio output	Phono jacks X2, L&R 327mV at 47kOhms	Phono jacks X2, L&R 327mV at 47 kOhms	Phono jacks X2, L&R (on CCU) A11 (0dBs=0.775Vrms)
Other connectors	-	-	External Mic IN: Stereo Mini Jack (on CCU)
Camera head to CCU cord length	Approx. 2m (6 feet)	Approx. 2m (6 feet)	Approx. 3m (10 feet)
NightShot	NA	NA	IR light effective distance: 20m w/ slow shutter ON 5m (w/o slow shutter)
Power requirements	7.2V DC	7.2V DC	7.2V DC
Power consumption	Approx. 1.8W	Approx. 1.8W	Approx. 2.2W, 3.2W w/ IR light ON
Weight camera unit	20g (0.7 oz)	75g (2.7 oz)	343g (12 oz)
Weight CCU	135g (4.8 oz)	135g (4.8 oz)	153g (5 oz)
Operating temperature	32 to 104° F (0 to 40° C)	32 to 104° F (0 to 40° C)	32 to 104° F (0 to 40° C)
Storage temperature	-4 to 140° F (-20 to 60° C)	-4 to 140° F (-20 to 60° C)	-4 to 140° F (-20 to 60° C)
Supplied accessories	Video walkman attachment unit, operating instructions	-	-

B/W CCD Cameras

	SSC-M383	SSC-M183
Pickup device	1/3 type Interline Transfer CCD with Exwave HAD technology	1/3 type Interline Transfer Super HAD CCD
Pic. Elements (HxV)	768 x 494	510 x 492
Lens mount	CS	CS
Signal system	EIA	EIA
Sync system	Internal/External	Internal/External
External sync	AC Line Lock (for AC 24 V)	AC Line Lock (for AC 24 V)
V-phase control	±90 °	±90 °
H-Phase control	–	–
Horizontal resolution	570 Lines	380 Lines
S/N ratio (AGC OFF)	Better than 50 dB	Better than 50 dB
Min. illumination (AGC, ON)	0.04 lx at F1.2 (30 IRE) 0.07 lx at F1.2 (50 IRE) 0.3 lx at F1.2 (100 IRE)	0.03 lx at F1.2 (30 IRE) 0.06 lx at F1.2 (50 IRE) 0.25 lx at F1.2 (100 IRE)
Video output	1.0 Vp-p, BNC (1)	1.0 Vp-p, BNC (1)
Operating temperature	-10 to 50 °C (14 to 122 °F)	-10 to 50 °C (14 to 122 °F)
Storage temperature	-40 to 60 °C (-40 to 140 °F)	-40 to 60 °C (-40 to 140 °F)
Power requirements	AC 24 V, 60 Hz / DC 12 V	AC 24 V, 60 Hz / DC 12 V
Power consumption	2.6 W	2.5 W
Mass	360 g (13 oz)	360 g (13 oz)
Dimensions (WxHxD), mm (inches)	60 x 54 x 120 (2 3/8" x 2 1/4" x 4 3/4")	60 x 54 x 120 (2 3/8" x 2 1/4" x 4 3/4")

SPECIFICATIONS

Vari-focal Lens Cameras

	SSC-CX13V	SSC-MX13V
Pickup device	1/4 type Interline Transfer Super HAD CCD	1/4 type Interline Transfer Super HAD CCD
Pic. Elements (HxV)	768 x 494	768 x 494
Built-in lens	Vari-focal lens f=2.8 to 5.8 mm, F1.4 Auto iris	Vari-focal lens f=2.8 to 5.8 mm, F1.4 Auto iris
View angle	W=95.7 °(D), 75.9 °(H), 56.4 °(V) T=47.3 °(D), 37.8 °(H), 28.4 °(V)	W=95.7 °(D), 75.9 °(H), 56.4 °(V) T=47.3 °(D), 37.8 °(H), 28.4 °(V)
Minimum object distance	0.2 m	0.2 m
Signal system	NTSC	EIA
White balance	ATW	—
Sync system	Internal/External	Internal/External
External sync	AC Line Lock (for AC 24 V)	AC Line Lock (for AC 24 V)
V-phase control	±90 °	±90 °
Horizontal resolution	480 Lines	570 Lines
S/N ratio (AGC OFF, weight ON)	Better than 50 dB	Better than 50 dB
Min. illumination (Turbo AGC ON)	1.1 lx at F1.4 (30 IRE) 1.8 lx at F1.4 (50 IRE)	0.2 lx at F1.4 (30 IRE) 0.3 lx at F1.4 (50 IRE)
AGC	Turbo AGC (up to 24 dB)/ Normal AGC (up to 18 dB), switchable	Turbo AGC (up to 24 dB)/ Normal AGC (up to 18 dB), switchable
Iris control mode	Auto Iris Lens	Auto Iris Lens
Video output	1.0 Vp-p, BNC (1)	1.0 Vp-p, BNC (1)
Operating temperature	-10 to 50 °C (14 to 122 °F)	-10 to 50 °C (14 to 122 °F)
Operating humidity	20 % to 80 % (non condensing)	20 % to 80 % (non condensing)
Input voltage	AC 24 V, 60 Hz/DC 12 V	AC 24 V, 60 Hz/DC 12 V
Power consumption	3.0 W	1.8 W
Mass	Approx 250 g (8.2 oz)	Approx 250 g (8.2 oz)
Dimensions (WxHxD) mm (inches)	58 x 54 x 133 (2 3/8" x 2 1/8" x 5 1/4")	58 x 54 x 133 (2 3/8" x 2 1/8" x 5 1/4")

Mini Fixed Dome Cameras

	SSC-CD53V	SSC-MD53V	SSC-CD33V	SSC-MD33V
Pickup device	1/4 type Interline Transfer Super HAD CCD	1/4 type Interline Transfer Super HAD CCD	1/4 type Interline Transfer Super HAD CCD	1/4 type Interline Transfer Super HAD CCD
Pic. Elements (HxV)	768 x 494	768 x 494	768 x 494	768 x 494
Built-in lens	Vari-focal lens f=2.8 to 5.8 mm, F1.4 Auto iris	Vari-focal lens f=2.8 to 5.8 mm, F1.4 Auto iris	Vari-focal lens f=2.8 to 5.8 mm, F1.4 Auto iris	Vari-focal lens f=2.8 to 5.8 mm, F1.4 Auto iris
View angle	W=95.7 ° (D), 75.9 ° (H), 56.4 ° (V) T=47.3 ° (D), 37.8 ° (H), 28.4 ° (V)	W=95.7 ° (D), 75.9 ° (H), 56.4 ° (V) T=47.3 ° (D), 37.8 ° (H), 28.4 ° (V)	W=95.7 ° (D), 75.9 ° (H), 56.4 ° (V) T=47.3 ° (D), 37.8 ° (H), 28.4 ° (V)	W=95.7 ° (D), 75.9 ° (H), 56.4 ° (V) T=47.3 ° (D), 37.8 ° (H), 28.4 ° (V)
Minimum object distance	0.2 m	0.2 m	0.2 m	0.2 m
Signal system	NTSC	EIA	NTSC	EIA
White balance	ATW	–	ATW	–
Sync system	Internal/External	Internal/External	Internal/External	Internal/External
External sync	AC Line Lock (for AC 24 V)	AC Line Lock (for AC 24 V)	AC Line Lock (for AC 24 V)	AC Line Lock (for AC 24 V)
V-phase control	±90 °	±90 °	±90 °	±90 °
Horizontal resolution	480 Lines	570 Lines	480 Lines	570 Lines
S/N ratio (AGC OFF, weight ON)	Better than 50 dB	Better than 50 dB	Better than 50 dB	Better than 50 dB
Min. illumination (Turbo AGC ON, Clear Cover)	1.2 lx at F1.4 (30 IRE) 2.0 lx at F1.4 (50 IRE)	0.2 lx at F1.4 (30 IRE) 0.4 lx at F1.4 (50 IRE)	1.2 lx at F1.4 (30 IRE) 2.0 lx at F1.4 (50 IRE)	0.2 lx at F1.4 (30 IRE) 0.4 lx at F1.4 (50 IRE)
AGC	Turbo AGC (up to 24 dB)/ Normal AGC (up to 18 dB) switchable	Turbo AGC (up to 24 dB)/ Normal AGC (up to 18 dB) switchable	Turbo AGC (up to 24 dB)/ Normal AGC (up to 18 dB) switchable	Turbo AGC (up to 24 dB)/ Normal AGC (up to 18 dB) switchable
Iris control mode	Auto Iris Lens	Auto Iris Lens	Auto Iris Lens	Auto Iris Lens
Video output	1.0 Vp-p, BNC (1)	1.0 Vp-p, BNC (1)	1.0 Vp-p, BNC (1)	1.0 Vp-p, BNC (1)
Weather proof	IP66	IP66	–	–
Operating temperature	-20 to 50 °C (4 to 122 °F)	-20 to 50 °C (4 to 122 °F)	-20 to 50 °C (4 to 122 °F)	-20 to 50 °C (4 to 122 °F)
Operating humidity	20 to 80 % (non condensing)	20 to 80 % (non condensing)	20 to 80 % (non condensing)	20 to 80 % (non condensing)
Input voltage	AC 24 V/DC 12 V	AC 24 V/DC 12 V	AC 24 V/DC 12 V	AC 24 V/DC 12 V
Power consumption	3.5 W	2.3 W	3.5 W	2.3 W
Mass	Approx 870 g (1lb 14 oz)	Approx 870 g (1lb 14 oz)	Approx 320 g (11 oz)	Approx 320 g (11 oz)
Dimensions (WxHxD), mm (inches)	Base approx. 137 x 105 x 138 (5 1/2" x 4 1/4" x 5 1/2") Bubble approx. 91 (ø) (3 5/8")	Base approx. 137 x 105 x 138 (5 1/2" x 4 1/4" x 5 1/2") Bubble approx. 91 (ø) (3 5/8")	Base approx. 117 x 95 x 118 (4 5/8" x 4 3/4" x 3 3/4") Bubble approx. 91 (ø) (3 5/8")	Base approx. 117 x 95 x 118 (4 5/8" x 4 3/4" x 3 3/4") Bubble approx. 91 (ø) (3 5/8")

SPECIFICATIONS

Camera Adaptors

	YS-W270	YS-W170
Video output	BNC (8), composite video	BNC (2), composite video
Video input	Camera In, BNC (4)	Camera In, BNC (1)
External sync	VS or VD-W	VS or VD-W
Internal sync	MPX-VS or MPX-VD-W	MPX-VS or MPX-VD-W
Max. cable length	300 m using RG-59B/U 500 m using RG-6A/U 600 m using RG-11A/U	300 m using RG-59B/U 500 m using RG-6A/U 600 m using RG-11A/U
Cable compensation	3-Position	3-Position
Power requirement	AC 120 V, 60Hz	AC 120 V, 60Hz
Power consumption	49.5 W	15 W
Operating temperature	-10 to 50 °C (14 to 122 °F)	-10 to 50 °C (14 to 122 °F)
Mass	3.6 kg (7 lb 15 oz)	1.9 kg (4 lb 3 oz)
Dimensions (WxHxD), mm (inches)	424 x 52 x 345 (16 3/4" x 2 1/8" x 13 5/8")	212 x 52 x 345 (8 3/8" x 2 1/8" x 13 5/8")

Color Monitors

	SSM-14N5U	SSM-20N5U	PVM-14N6U	PVM-20N6U
Picture tube	14-inch (37.1 cm), visible picture size 13-inch (33.2 cm) measured diagonally, 90-degree deflection, AG pitch 0.25 mm	20-inch (52.2 cm), visible picture size 19-inch (48.1 cm) measured diagonally, 90-degree deflection, AG pitch 0.4 mm	14-inch (37.1 cm), visible picture size 13-inch (33.2 cm) measured diagonally, 90-degree deflection, AG pitch 0.25 mm	20-inch (52.2 cm), visible picture size 19-inch (48.1 cm) measured diagonally, 90-degree deflection, AG pitch 0.4 mm
TV System/color standard	NTSC/PAL/SECAM/NTSC4.43	NTSC/PAL/SECAM/NTSC4.43	NTSC/PAL/SECAM/NTSC4.43	NTSC/PAL/SECAM/NTSC4.43
Horizontal resolution	500 lines at center	500 lines at center	500 lines at center	500 lines at center
Video input	Composite video (BNC (1)), S Video (Mini DIN 4-pin (1))	Composite video (BNC (1)), S Video (Mini DIN 4-pin (1))	Composite Video (BNC (2)), S-Video (Mini DIN 4-pin(2)) RGB/Sync input : BNC	Composite Video (BNC (2)), S-Video (Mini DIN 4-pin(2)) RGB/Sync input : BNC
Video output	Composite video (BNC (1)), S Video (Mini DIN 4-pin (1))	Composite video (BNC (1)), S Video (Mini DIN 4-pin (1))	Composite Video (BNC (1)), S-Video (Mini DIN 4-pin(1))	Composite Video (BNC (1)), S-Video (Mini DIN 4-pin(1))
Audio input	Phono (1)	Phono (1)	Phono (3)	Phono (3)
Audio output	Phono (1), 500 mV rms	Phono (1), 500 mV rms	Phono (1), 500mV rms	Phono (1), 500mV rms
Built-in speaker	Yes	Yes	Yes	Yes
Power requirement	AC 100 to 240 V, 50/60 Hz+	AC 100 to 240 V, 50/60 Hz+	AC 100 to 240 V, 50/60 Hz+	AC 100 to 240 V, 50/60 Hz+
Power consumption	80 W	100 W	80 W	100 W
Mass	15 kg (33 lb 1 oz)	28 kg (61 lb 11 oz)	15 kg (33 lb 1 oz)	28 kg (61 lb 11 oz)
Dimensions (WxHxD), mm (inches)	346 x 340 x 414 (13 5/8" x 13 3/8" x 16 5/16")	449 x 441 x 502 (17 11/16" x 17 3/8" x 19 3/4")	346 x 340 x 414 (13 5/8" x 13 3/8" x 16 5/16")	449 x 441 x 502 (17 11/16" x 17 3/8" x 19 3/4")

+UL listed for AC120 V, 60 Hz operation only

Color Monitors

	PVM-8045Q	PVM-8042Q	PVM-8040
Picture tube	9-inch (22 cm), visible picture size 8-inch (19.1 cm) measured diagonally, 70-degree deflection, AG pitch 0.25 mm	9-inch (22 cm), visible picture size 8-inch (19.7 cm) measured diagonally, 70-degree deflection, AG pitch 0.5 mm	9-inch (22 cm), visible picture size 8-inch (19.7 cm) measured diagonally, 70-degree deflection, AG pitch 0.5 mm
TV System/color standard	NTSC/PAL/SECAM/NTSC4.43	NTSC/PAL/SECAM/NTSC4.43	NTSC
Horizontal resolution	450 lines at center	250 lines at center	250 lines at center
Video input	Composite Video (BNC (2)), S-Video (Mini DIN 4-pin(1)) RGB/component (Y, R-Y, B-Y) input : BNC	Composite Video (BNC (2)), S-Video (Mini DIN 4-pin(1)) RGB/component (Y, R-Y, B-Y) input : BNC	Composite Video (BNC (1)), S-Video (Mini DIN 4-pin(1))
Video output	Composite Video (BNC (2)), S-Video (Mini DIN 4-pin(1))	Composite Video (BNC (2)), S-Video (Mini DIN 4-pin(1))	Composite Video (BNC (1)), S-Video (Mini DIN 4-pin(1))
Audio input	Phono (3)	Phono (3)	Phono (1)
Audio output	Phono (2)	Phono (2)	Phono (1)
Built-in speaker	Yes	Yes	Yes
Power requirement	AC: AC 100 to 240 V, 0.7 to 0.4 A, 50/60 Hz+ DC: 12 V 3.7 A	AC: AC 100 to 240 V, 0.7 to 0.4 A, 50/60 Hz+ DC: 12 V 3.7 A	AC 100 to 240 V, 0.7 to 0.4 A, 50/60 Hz+
Power consumption	AC: 45 W max. DC: 41 W	AC: 45 W max. DC: 41 W	39 W max.
Mass	8.2 kg (18 lb)	8.2 kg (18 lb)	7.8 kg (17 lb 3 oz)
Dimensions (WxHxD), mm (inches)	217 x 217 x 352.5 (8 5/8" x 8 5/8" x 14")	217 x 217 x 352.5 (8 5/8" x 8 5/8" x 14")	217 x 217 x 352.5 (8 5/8" x 8 5/8" x 14")

+UL listed for AC120 V, 60 Hz operation only

SPECIFICATIONS

Digital Time Lapse Video Recorders

	HSR-X200	HSR-1/1	HSR-2
HDD capacity	80 GB/HDD Unit (160 GB: up to 2 HDDs)	More than 4 GB	More than 20 GB
Playback during recording	Yes	No	Yes
Video signal	EIA standard, NTSC color	EIA standard, NTSC color	EIA standard, NTSC color
Recording system	–	Rotary two-head helical scanning system	Rotary two-head helical scanning system
Quantization	8-bit	8-bit	8-bit
Sampling frequency	13.5 MHz(4 : 2 : 2 components)	13.5 MHz (4 : 1 : 1 components)	13.5 MHz (4 : 1 : 1 components)
Recording/playback time	Maximum 11113 hours (Approx. 463 days)	Maximum 9999 hours (Approx. 400 days)	Maximum 9999 hours (Approx. 400 days)
Fast forward/rewind time	–	Less than 3 min. (with a 270-minute tape)	Less than 3 min. (with a 270-minute tape)
Video input	VBS, VS (BNC type) : 1.0 Vp-p, 75 Ω, unbalanced S-VIDEO (DIN 4-pin): Y: 1.0 Vp-p, 75 Ω, sync negative C: 0.3 Vp-p, 75 Ω, at burst level	VBS, VS (BNC type) : 1.0 Vp-p, 75 Ω, unbalanced	VBS, VS (BNC type) : 1.0 Vp-p, 75 Ω, unbalanced
Video output	VBS (BNC type) : 1.0 Vp-p, 75 Ω, unbalanced S-VIDEO (DIN 4-pin) : Y : 1.0 Vp-p, 75 Ω, sync negative C : 0.3 Vp-p, 75 Ω, at burst level	VBS (BNC type) : 1.0 Vp-p, 75 Ω, unbalanced S-VIDEO (DIN 4-pin) : Y : 1.0 Vp-p, 75 Ω, sync negative C : 0.3 Vp-p, 75 Ω, at burst level	VBS (BNC type): 1.0 Vp-p, 75 Ω, unbalanced S-VIDEO (DIN 4-pin): Y: 1.0 Vp-p, 75 Ω, sync negative C: 0.3 Vp-p, 75 Ω, at burst level
Split screen display	–	9 patterns	9 patterns
Quality mode	Hyper, Super, High, Middle and Low modes (selectable)	Super, High, Middle and Low modes (selectable)	Super, High, Middle and Low modes (selectable)
Horizontal resolution	More than 500 TV lines (Hyper mode)	More than 500 TV lines (Hyper and Super modes) 360 TV lines (High mode)	More than 500 TV lines (Hyper and Super modes) 360 TV lines (High mode)
S/N ratio	48 dB (typical)	More than 48 dB	More than 48 dB
Mass	5.5 kg (12 lb 2 oz)	10 kg (22 lb 1 oz)	10 kg (22 lb 1 oz)
Dimensions (WxHxD), mm (inches)	420 x 96 x 376 (16 5/8" x 3 7/8" x 14 7/8")	355 x 125 x 410 (14" x 5" x 16 1/4")	355 x 125 x 410 (14" x 5" x 16 1/4")
Power requirements	AC 120 V ±10%, 60 Hz	AC 100 to 120 V, 50/60 Hz	AC 100 to 120 V, 50/60 Hz
Power consumption	0.4 A	58 W (without options), 78 W (with full options)	58 W (without options), 78 W (with full options)
Operating temperature	5 to 40 °C (41 to 104 °F)	5 to 40 °C (41 to 104 °F)	5 to 40 °C (41 to 104 °F)
Recording/back-up media	–	DV or DVCAM cassette tape (standard size, mini size)	DV or DVCAM cassette tape (standard size, mini size)
Parallel input/output connectors	D-SUB 9-pin (1) 11 terminals (Alarm terminals) 11 terminals (Control terminals)	D-SUB 37-pin (1) 24 terminals (Input), 8 terminals (Output) to be freely assigned (Alarm, Rec. Tally, Clock set, Series rec. etc.) Power output: +12 V (max. 100 mA)	D-SUB 37-pin (1) 24 terminals (Input), 8 terminals (Output) to be freely assigned (Alarm, Rec. Tally, Clock set, Series rec. etc.) Power output: +12 V (max. 100 mA)
Control S connector	–	Stereo mini (1)	Stereo mini (1)

Analog Time Lapse Video Recorders

	SVT-RA168	SVT-RA40
Tape format	VHS	VHS
Tape speed	11.12 mm/s (6 or 8-hour mode)	11.12 mm/s (6 or 8-hour mode)
Fast forward/rewind time	Approx. 100 seconds (with a T-120 tape)	Approx. 100 seconds (with a T-120 tape)
Recording system	Rotary four-head helical scanning system	Rotary four-head helical scanning system
Video input	BNC: 1.0 Vp-p, 75 Ω , unbalanced	BNC: 1.0 Vp-p, 75 Ω , unbalanced
Video output	BNC: 1.0 Vp-p, 75 Ω , unbalanced	BNC: 1.0 Vp-p, 75 Ω , unbalanced
Recording modes	6-168 Hrs. (with a T-120 tape) 8-224 Hrs. (with a T-160 tape)	6, 18, 30 Hrs. (with a T-120 tape) 8, 24, 40 Hrs. (with a T-160 tape)
Record interval (Approx.)	1/60 to 0.48 s	1/60 to 1/12 s
Mic input	ϕ 3.5 mm Mini-jack, -60 dB, 600 Ω	ϕ 3.5 mm Mini-jack, -60 dB, 600 Ω
Audio recording	6 (8), 18 (24), 30 (40) Hour Mode	6 (8), 18 (24), 30 (40) Hour Mode
Audio input	-8 dB, 27 k Ω (phono jack)	-8 dB, 27 k Ω (phono jack)
Audio output	-8 dB, 600 Ω (phono jack)	-8 dB, 600 Ω (phono jack)
Audio S/N ratio	42 dB	42 dB
Horizontal resolution	350 Lines (B/W), 300 Lines (Color)	350 Lines (B/W), 300 Lines (Color)
S/N ratio	44 dB	44 dB
Remote control interface	ϕ 3.5 mm Mini-jack RS-232C/RS-485 interface (option)	ϕ 3.5 mm Mini-jack RS-232C/RS-485 interface (option)
Time/date	Yes	Yes
Built-in timer	7-Day/8-Event	7-Day/8-Event
Alarm input	Low level	Low level
Alarm output	+5 V, 5.7 k Ω (Low active)	+5 V, 5.7 k Ω (Low active)
Alarm REC. speed	8 (6), 24 (18), 40 (30) Hrs. or No change	8 (6), 24 (18), 40 (30) Hrs. or No change
Alarm search	Yes	Yes
Alarm scan	Yes	Yes
Alarm data list	Yes	Yes
Video loss alert	Yes	Yes
Operating temperature	5 to 40 $^{\circ}$ C (41 to 104 $^{\circ}$ F)	5 to 40 $^{\circ}$ C (41 to 104 $^{\circ}$ F)
Power requirement	AC 120 V, 60 Hz	AC 120 V, 60 Hz
Power consumption	16 W	16 W
Mass	4.1 kg (9 lb)	4.1 kg (9 lb)
Dimensions (WxHxD), mm (inches)	420 x 100 x 300 (16 ⁵ / ₈ " x 4" x 11 ⁷ / ₈ ")	420 x 100 x 300 (16 ⁵ / ₈ " x 4" x 11 ⁷ / ₈ ")

SPECIFICATIONS

Analog Time Lapse Video Recorders

SVT-124

Tape format	VHS
Tape speed	33.35 mm/s (2-hour mode)
Fast forward/rewind time	Approx. 2.5 minutes (with a T-120 tape)
Recording system	Rotary four-head helical scanning system
Video input	BNC: 1.0 V _{p-p} , 75 Ω, unbalanced
Video output	BNC: 1.0 V _{p-p} , 75 Ω, unbalanced
Recording modes	2, 12, 24 Hrs. (with a T-120 tape)
Record interval (Approx.)	1/60 to 0.22 s
Mic input	φ 3.5 mm Mini-jack, -60 dB, 10 kΩ
Audio recording	2, 12, 24 Hour Mode
Audio input	-8 dB, 27 kΩ (phono jack)
Audio output	-8 dB, 600 Ω (phone jack)
Audio S/N ratio	42 dB
Horizontal resolution	350 Lines (B/W), 300 Lines (Color)
S/N ratio	44 dB
Remote control interface	–
Time/date	–
Built-in timer	7-Day/8-Event
Alarm input	Low level
Alarm output	+5 V, 5.7 kΩ (Low active)
Alarm REC. speed	2, 12 Hrs. or No change
Alarm search	–
Alarm scan	Yes
Alarm data list	Yes
Video loss alert	–
Operating temperature	5 to 40 °C (41 to 104 °F)
Power requirement	AC 120 V, 60 Hz
Power consumption	17 W
Mass	3.8 kg (8 lb 6 oz)
Dimensions (WxHxD), mm (inches)	240 x 96.5 x 333 (9 1/2" x 3 7/8" x 13 1/8")

Standard Video Recorders

	SVO-1330	EVO-250	PGV-250
Tape format	VHS NTSC standard	Hi8/Standard 8 mm (SP/LP)	—
Tape speed	SP: 33.35 mm/s (1 3/8 inches/s) EP: 11.12 mm/s (7/16 inches/s)	Fast forward/rewind time Approx. 6 min. (with Sony a P6-120 cassette)	—
Fast forward/rewind time	Approx. 2 min. 30 seconds (with a T-120 tape)	Recording system Rotary Dual-Head Helical Scanning FM System	—
Recording system	Rotary four-head helical scanning FM system	Video input Composite (1) (phono type) 4-pin Mini DIN (1), Y/C	Composite (1) (phono type) 4-pin Mini DIN (1), Y/C
Video input	BNC: 1.0 Vp-p, 75 Ω, unbalanced	Video output Composite (1) (phono type) 4-pin Mini DIN (1), Y/C	Composite (1) (phono type) 4-pin Mini DIN (1), Y/C
Video output	BNC: 1.0 Vp-p, 75 Ω, unbalanced	Recording modes SP: 2 Hrs. 30 min. LP: 5 Hrs. (with Sony a P6-150 cassette)	—
Audio input	Phono (1): -8 dB (0 dB = 0.775 Vrms) impedance: more than 47 kΩ	Audio recording system Rotary Head, FM Stereo System	—
Audio output	Phono (1): -8 dB (0 dB = 0.775 Vrms) impedance: less than 10 kΩ	Audio input -7.5 dB, phono (2) (stereo)/ -7.5 dB, phono (2) (stereo)	Phono (2), -7.5 dB (Line)/-60 dB (Mic) Selectable (0 dB = 0.775 Vrms)
Audio S/N ratio	40 dB	Audio output -7.5 dB, phono (2) (stereo)/ -7.5 dB, phono (2) (stereo)	Phono (2), -7.5 dB (Line)/-60 dB (Mic) Selectable (0 dB = 0.775 Vrms)
Horizontal resolution	240 lines (SP)	Alarm input —	Contact closure: Active short
S/N ratio	44 dB (SP)	Operating temperature 0 to 40 °C (32 to 104 °F)	5 to 40 °C (41 to 104 °F)
Frequency response	50 Hz to 10 kHz	Power requirement 7.2 V (Battery pack) 8.4 V (AC Power Adaptor AC-V615)	DC 5.3 V, 120 MA
Operating temperature	5 to 40 °C (41 to 104 °F)	Power consumption 2.9 W	8.7 V, 1 VA
Power requirement	20 V AC, 60 Hz	Mass Approx. 650 g (1 lb 7 oz) without battery	Approx. 160 g (5.6 oz) main unit Approx. 60 g (2 oz) DC power supply unit
Power consumption	14 W (max.)	Dimensions (WxHxD), mm (inches) 148 x 48 x 135 (5 13/16" x 1 7/8" x 5 3/8")	69.5 x 60.6 x 134.8 (2 3/4" x 2 3/8" x 5 5/16")
Mass	Approx. 3.7 kg (8 lb 13 oz)		
Dimensions (WxHxD), mm (inches)	360 x 98 x 295 (14 1/4" x 3 7/8" x 11 5/8")		

SPECIFICATIONS

Multiplexers

	YS-DX516	YS-DX416	YS-DX504
Multiplexer type	Duplex color	Duplex B/W	Half Duplex Color
No. of video inputs	16	16	4
Video signal	NTSC color	EIA B/W	NTSC color
Video input	BNC (16) composite video	BNC (16) composite video	BNC (4) composite video
VCR input	BNC (1) composite video 4-pin Mini DIN (1), Y/C	BNC (1) composite video	BNC (1) composite video 4-pin Mini DIN (1), Y/C
VCR output	BNC (1) composite video 4-pin Mini DIN (2), Y/C	BNC (1) composite video	BNC (1) composite video 4-pin Mini DIN (1), Y/C
Resolution	720 (H) x 564 (V) pixels	720 (H) x 564 (V) pixels	720 (H) x 564 (V) pixels
Monitor outputs	BNC (2), composite video	BNC (2), composite video	BNC (2), composite video
Digital still/zoom	Yes, 2x zoom	Yes, 2x zoom	Yes, 2x zoom
Alarm input	16	16	4
External alarm output	1	1	1
Sensor alarm output	16	16	4
Video loss alert	Yes	Yes	Yes
Battery backup	30 days	30 days	30 days
Power requirement	AC 120 V, 60 Hz	AC 120 V, 60 Hz	AC 120 V, 60 Hz
Power consumption	21 W	18 W	19 W
Operating temperature	5 to 40 °C (37 to 104 °F)	5 to 40 °C (37 to 104 °F)	5 to 40 °C (37 to 104 °F)
Mass	4.1 kg (9 lb 4 oz)	4.1 kg (9 lb 4 oz)	3.4 kg (7 lb 8 oz)
Dimensions (WxHxD), mm (inches)	420 x 86 x 325 (16 5/8" x 3 1/2" x 12 7/8")	420 x 86 x 325 (16 5/8" x 3 1/2" x 12 7/8")	420 x 44 x 325 (16 5/8" x 1 3/4" x 12 7/8")

	UP-20	UP-960
Printing method	Dye sublimation printing	Direct thermal printing
Resolution	403 dpi	163 dpi
Gradation	256 levels per dot per color (over 16.7m colors per dot)	256 grey levels
Effective print pixels	S Size: 1524 x 976 dots L Size: 2032 x 1452 dots	(EIA)1280 x 508 dots (CCIR)1280 x 608 dots (Wide 2 mode)
Paper size	S Size: 90 x 100 mm L Size: 144 x 100 mm	– –
Print area	S Size: 3 ³ / ₄ " x 2 ⁷ / ₈ " L Size: 5" x 3 ⁵ / ₈ " – – – – – –	(EIA) Standard mode: 190 x 142 mm (7 ¹ / ₂ " x 5 ⁵ / ₈ ") Side mode: 181 x 243 mm (7 ¹ / ₄ " x 9 ⁵ / ₈ ") (CCIR) Standard mode: 190 x 144 mm (7 ¹ / ₂ " x 5 ³ / ₄ ") Side mode: 184 x 243 mm (7 ¹ / ₄ " x 9 ⁵ / ₈ ") (Wide 2 mode)
Printing time	Approx. 16 seconds (UPG-21S) Approx. 25 seconds (UPG-21L)	Approx. 10 seconds per screen
Picture memory	4 frame memory	2048 x 1024 x 8 bit
Inputs/Outputs	Composite Video/S-Video	Video
Control terminals	RS232C, Remote 1/2	Stereo mini
Power requirements	AC 100 to 120 V, 220-240 V	AC 100 to 120 V, 220 to 240 V, 50/60 Hz
Power consumption	1.8 A @ 110 V	100 to 120 V: 2.4 A, 220 to 240 V: 1.3 A
Mass	6.5 kg (13.3 lbs)	8 kg (17 lb 10 oz)
Dimensions (WxHxD), mm (inches)	Approx. 213 x 127 x 397 (8 ³ / ₈ " x 5" x 15 ⁵ / ₈ ")	316 x 132 x 305 (12 ¹ / ₂ " x 5 ¹ / ₄ " x 12 ¹ / ₈ ")
Print paper/ Accessories	UPC-21L Large Size Color Print Media 4 x 50 Packs (5" x 3.6") UPC-21S Small Size Color Print Media 3 x 80 Packs (3.8" x 2.9") RM-5500 Wired/Wireless RM-91 Remote Control Unit FS-36 Foot Switch FS-20 Foot Switch UPA-21SA Slide Adaptor	UPP-210HD Type II High Density Print Paper (for 126 prints) UPP-210SE Type II Normal Density Print Paper (for 126 prints) RM-91 Remote Control Unit FS-20 Foot Switch

All print quantity numbers are measured in default setting.

All non-metric weights and measures are approximate.

Video Network Station

SNT-V304

Video inputs VBS/VS, BNC type (4), Auto sensing for NTSC or PAL with 75 Ω termination on/off dip-switch
S-Video, S terminal connector x (1)
Alternative VIDEO 1

Serial port RS-232C, D-sub 9 pin (2)
COM 1: EVI-D30/D31, camera control
HSR-1/1, HSR-2 digital recorder control
COM 2: EVI-D30/D31, Uni-Dome camera control
Modem port

Alarm inputs Terminal connector (4), positive ON/negative ON

Alarm outputs Terminal connector (1), Relay out

Ethernet connector RJ45 (1), 100 Base-TX/10 Base-T Ethernet

Compression method JPEG

Maximum performance NTSC 30 frame/s (352 x 240 resolution)
3 frame/s (704 x 480 resolution)
PAL 25 frame/s (352 x 288 resolution)
2 frame/s (704 x 576 resolution)

Bandwidth Control 0.1 to 2.0 M bit/s or Unlimited

Camera View modes Full size (352 x 240/NTSC, 352 x 288/PAL)
Huge size (704 x 480/NTSC, 704 x 576/PAL)

Sequence dwell time 5 to 30 seconds, 1 second steps

Alarm Activation Relay out
e-mail (SMTP) or forward to server (FTP)

Alarm dwell time 1 to 30 seconds or manual reset

Alarm image size Full size (352 x 240/NTSC, 352 x 288/PAL)

Buffering interval time 10, 5, 4, 3, 2, 1, 1/2, 1/3, 1/4, 1/5 s

Power requirements AC 12 V, 5.5W (with supplied AC adaptor)

Mass 0.8 kg (1 lb 12 oz) (not including AC adaptor)

**Dimensions (WxHxD),
mm (inches)** 146 x 41.5 x 223.5
(5 ³/₄" x 1 ¹¹/₁₆" x 8 ⁷/₈")

Cameras: Typical System

SNC-VL10N/SNC-RZ30N Operation

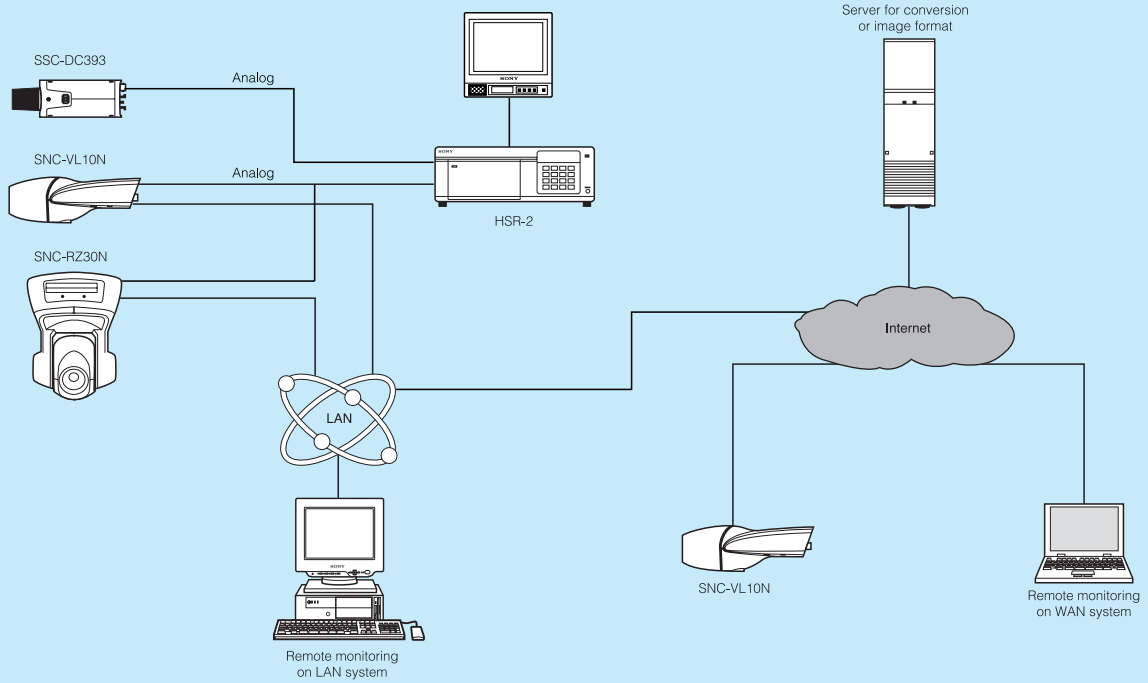

SNT-V304 Operation

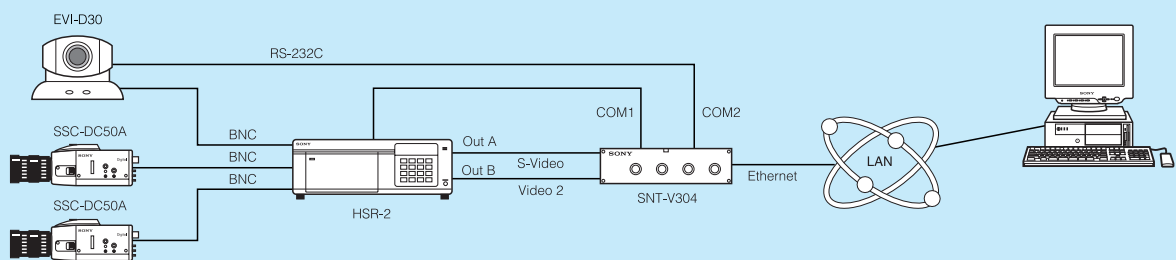

Cameras: Typical System

SSC-DC50A operation

1. Single camera operation

(a) Mode A: Triple multiplexing operation

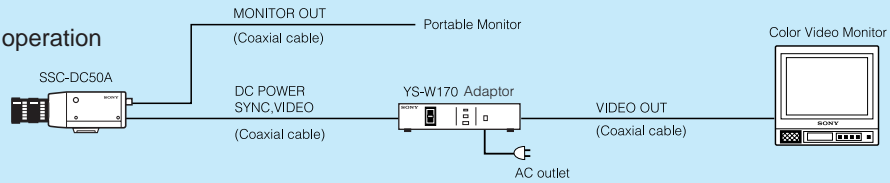

(b) Mode B: DC 12 V operation

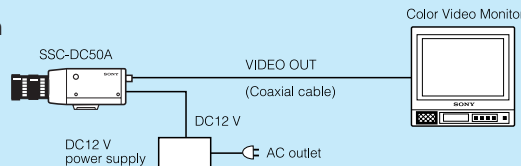

2. Multiple camera operation

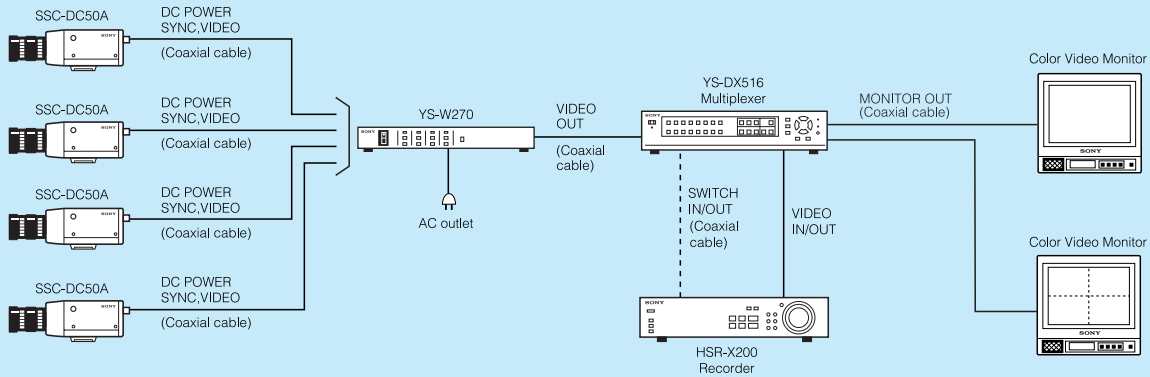

SSC-DC54A/DC593/DC393/DC193/M383/M183/CX13V/MX13V/CD53V/CD33V/MD53V/MD33V operation

1. Single camera operation

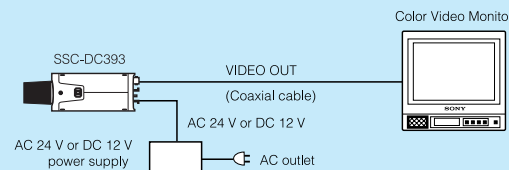

*SSC-DC54A does not perform DC 12 V operation.

2. Multiple camera operation

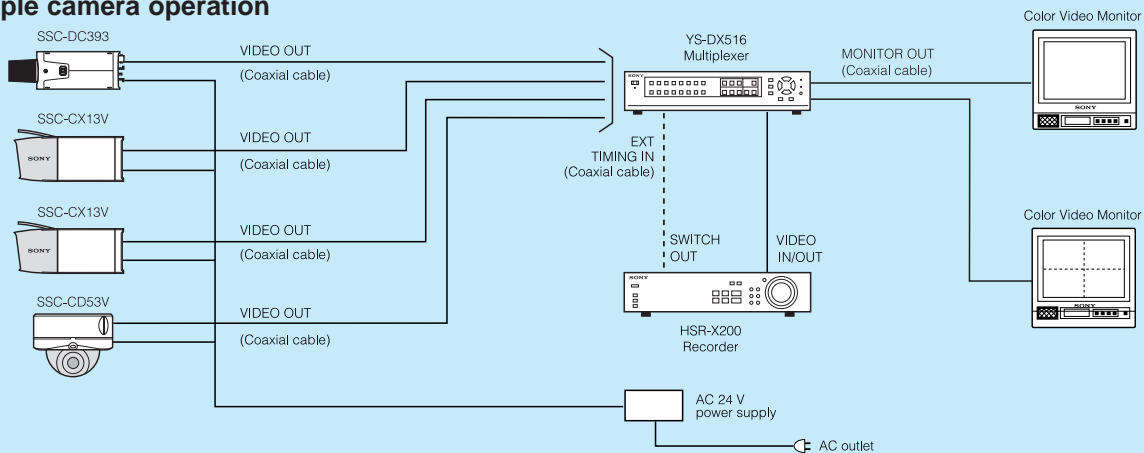

Multiplexers: Typical System

Single YS-DX516/DX416/DX504* operation

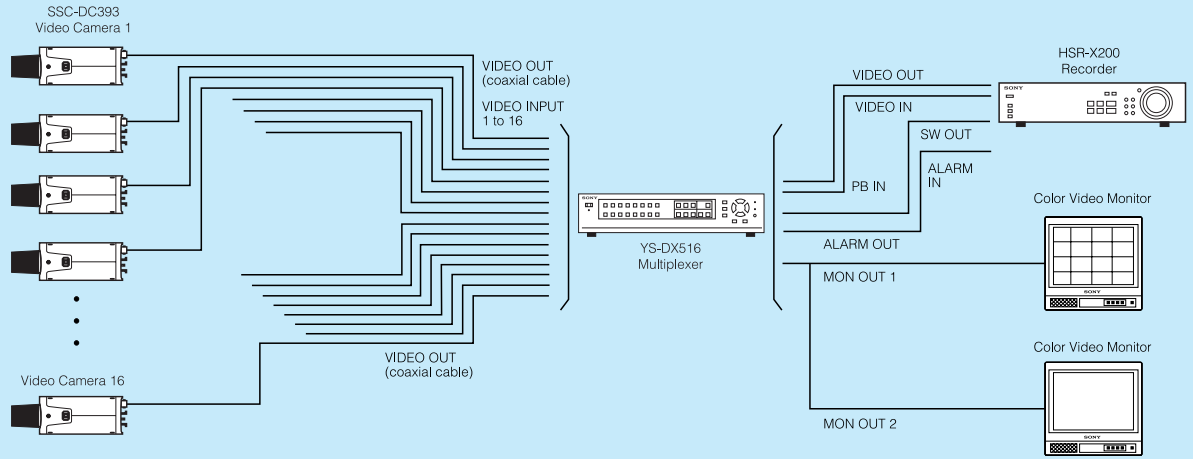

*Up to 4 cameras can be connected

Automatic gain control (AGC)

Amplifies existing video to help camera reproduce a video signal at very low light levels.

Analog backlight compensation (BLC)

Picture brightness adjusted automatically depending on lighting conditions. Overcomes the problem of strong backlight which often causes the subject of the picture to be cast into shadow.

Adaptive picture control (APC)

Automatically detects the condition of the recording head and video cassette tape and then sets the optimum recording head current. Available on all SVT time lapse VCRs.

Aperture/sharp mode

Makes object outline in the picture appear sharper. Ideal for situations where an object merges into the scene with a similar shade of color.

Auto tracing white balance (ATW)

Adjusts the white balance automatically in response to varying light conditions.

ATW PRO

Ideal for frequently changing light conditions and applications where the operator needs to see objects as they appear to the eye. Effective operational color range is 2500 to 6000K.

Auto iris

Automatically adjusts the iris element as the light level changes.

Auto white balance (AWB)

Automatically memorizes adjusted white balance values.

Backlight compensation

See Smart Control (Digital)
See Analog backlight compensation (Analog)

C mount

Type of camera mount which measures 17.5 mm from the lens rear mounting surface to the camera's CCD.

CS mount

Type of camera mount which measures 12.5 mm from the lens rear mounting surface to the camera's CCD. CS mount lenses can be used with C mount cameras by adding a 5 mm spacer.

DC servo auto iris lens

Lens that relies on DC power from the camera to control the iris.

Digital Signal Processing (DSP)

Converts the analog signal from a CCD image sensor into a digital signal through an internal A/D converter. The signal is then broken down into luminance and chrominance components for processing, adjustment and feature enhancement enabling many digital features such as backlight compensation.

Duplex

Type of multiplexer allowing simultaneous live monitoring or playback as images are being recorded.

Exwave HAD Technology

Sony's new technology with a nearly gap-less OCL (On-chip-lens) located over each pixel on the CCD resulting in more than twice the sensitivity and 1/50 the smear compared to the Hyper HAD technology. Used in SSC-DC50A/DC54A/DC393/M383 cameras.

Hybrid recording

Original Sony recording method of the HSR-1/1 and HSR-2, which uses both a Hard Disk Drive and DV tape. Images are first recorded to HDD, then transferred to DV tape.

Hyper HAD Technology

Technology with an OCL (On-chip-lens) located over each pixel on the CCD which helps increase sensitivity and reduce smear.

Real Action recording

EP recording mode which achieves four times as many frames/s to be recorded in 24 H mode. (SVT-RA168/RA40 only)

Sensitivity

The amount of light falling on a scene measured in lux.

Simplex

Type of multiplexer which allows the user to choose between live monitoring, recording or playback.

Smart Control

Digital circuit within the camera providing automatic backlight compensation by automatically adjusting iris and gain. Also see DSP.

Smear

Vertical streaks above and below a brightly lit object or light source when observed on the monitor. Vertical lines on the screen are caused by the leakage of unwanted light onto the vertical shift register of the CCD.

Super HAD Technology

Technology that drastically improves the sensitivity compared to the Hyper HAD technology by optimizing the shape of on-chip microlenses on the CCD in order to minimize the invalid area between microlenses of each pixel.

Synchronization

Used in multi-camera installations where automatic switching is employed and allows roll-free switching from camera to camera.

Trinitron CRT

Sony CRT which allows for high resolution and the best possible picture reproduction. The completely flat, straight vertical surface of the Trinitron CRT provides very low purity imperfection.

Triple multiplexing

Video, sync and power transmitted over a single coaxial cable.

Turbo AGC

Powerful automatic gain control function. Increases range of video gain compared to conventional AGC resulting in greater sensitivity.

Video servo auto iris lens

Lens that relies on video input to control the iris opening. When the video level is high, the lens iris closes. When the video level is low, it opens.

Products	Features	Specifications
CVX-V1	7	24
CVX-V18NS/SEC	7	24
CVX-V3	7	24
EVO-250	17	33
HSR-1/1, HSR-2	14	30
HSR-X200	14	30
PGV-250	17	33
PVM-14N6U	12	28
PVM-20N6U	12	28
PVM-8040	13	29
PVM-8042Q	13	29
PVM-8045Q	13	29
SNT-V304	20	36
SNC-VL10N/VL10P	4	22
SNC-RZ30N	4	22
SSC-CD33V	9	27
SSC-CD53V	9	27
SSC-CX13V	9	26
SSC-DC193	5	23
SSC-DC393	5	23
SSC-DC593	6	23
SSC-DC50A/DC54A	6	23
SSC-M183	8	25
SSC-M383	8	25
SSC-MD33V	9	27
SSC-MD53V	9	27
SSC-MX13V	9	26
SSM-14N5U	12	28
SSM-20N5U	12	28
SVO-1330	16	33
SVT-124	16	32
SVT-RA168	15	31
SVT-RA40	15	31
UNI-DN25S0/UNI-DN25FI	10	–
UNI-DNI8SI/UNI-DI8FI	10	–
UP-20	19	35
UP-960	19	35
YS-DX504	18	34
YS-DX516/DX416	18	34
YS-W170	11	28
YS-W270	11	28



A series of horizontal dashed lines for writing.

SONY

Sony Electronics Inc.
1 Sony Drive
Park Ridge, NJ 07656
www.sony.com/security

© 2002 Sony Electronics Inc. All rights reserved.
Reproduction in whole or in part without written permission is prohibited.
Features and specifications are subject to change without notice.
All non-metric weights and measures are approximate.
Sony and Trinitron are registered trademarks of Sony.
Hyper HAD, Exwave HAD, Super HAD CCD, DynaView, Smart Control, LaserLink,
NightShot and SteadyShot are trademarks of Sony.
All other trademarks are property of their respective owners.